

2019 NEW PRODUCTS



BOOTH

Indoor / Outdoor

Architectural and Retail Lighting



TARGETTI GROUP is one of the most respected and recognized manufacturers of sophisticated architectural lighting solutions for the international lighting community. Targetti USA offers a wide range of products are suitable for many different applications and are characterized by a high level of quality, design, functionality, performance and compliance with North American standards including UL/ETL, ADA, Title 24, NEC. Every Targetti product expresses the values the company holds dear. On one hand perfect light control and excellent performance, and on the other extreme attention to aesthetic detail. We cater to designers to provide flexible solutions that can meet even the most complex aesthetic and functional needs.

Cover:

Boston Arts Plaza, Boston University
Landscape Architect: Mikyoung Kim Design
Architect: Elkus Manfredi Architects
©Robert Benson Photography

Photo Right:

The Pools Park, Irvine, CA.
Lighting Design: StudioK1
Developer: FivePoint
Great Park Neighborhoods
Photos: ©Brad Nelson



www.targetti.us



www.targetti.us

ZEDGE FAMILY

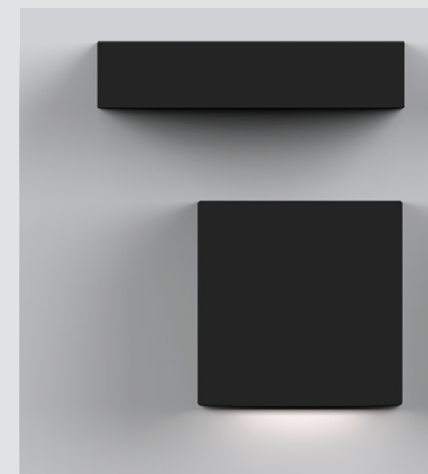

...One of Targetti's most complete collections

to address your OUTDOOR WALL RECESSED applications.

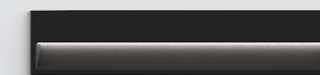

Designed in collaboration with Gensler,

the ZEDGE Family originated with the award-winning ZEDGE and ZEDGE PRO Step Lights and now includes the addition of ZEDGE Line, a compact linear luminaire, and MR. and MRS. SMITH, complimentary square appliques.



The ZEDGE family delivers a full offering of versatile sizes

and light effects with a cohesive and coordinated aesthetic.

ZEDGE LINE

DIMENSIONS

2.5" X 12"

LED

2700K / 3000K / 4000K

VOLTAGE

24V

FINISH



The ZEDGE LINE is a compact linear LED luminaire with the versatility

to be installed in both indoor and outdoor applications. Available in three color temperatures and a choice of power supplies.

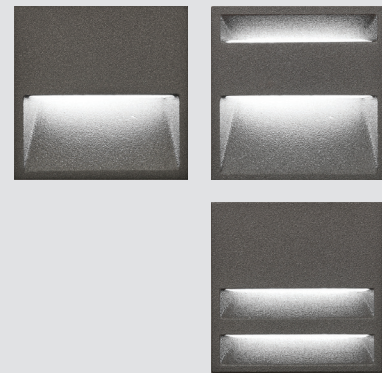

Designed to coordinate with the ZEDGE Family of products

such as the ZEDGE LED step marker which has a minimal design and compact size (2.5"x 2.5") and is available with three faceplate styles and 13 standard finishes.

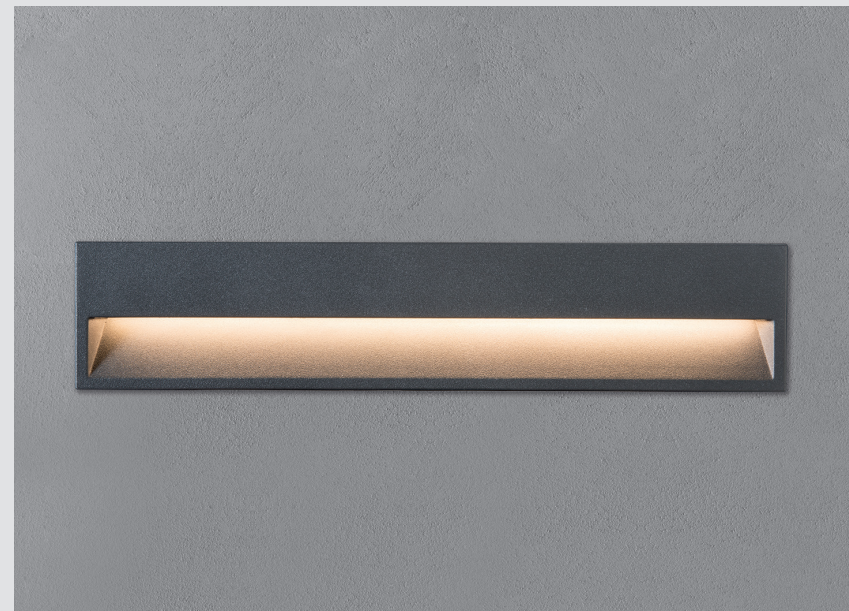

ZEDGE PRO BOLLARD

The ZEDGE PRO BOLLARD was designed to provide the ultimate in design flexibility

and ease of installation. Available in three popular sizes, the ZEDGE PRO Bollard delivers three solutions in one product. The innovative design consists of a single frame that when adjusted, delivers a Deep, Wide, and an Adjustable Optic. Designed to coordinate with the ZEDGE Family of products.

DIMENSIONS

7.87"W. Available in Three Heights: 16" / 32" / 40"

LED

2700K / 3000K / 4000K

DIMMING

0-10V

VOLTAGE

120-277V UNV

FINISH

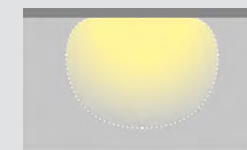
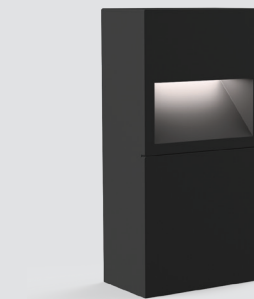

DEEP Optic



WIDE Optic

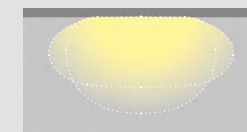

ADJUSTABLE Optic



MR. SMITH



MR. SMITH is a new outdoor applique designed to provide designers

with a wall sconce luminaire to be used on its own to create a dramatic visual setting or in coordination with the ZEDGE family.

LED
2700K / 3000K / 4000K

COLORS



MRS. SMITH

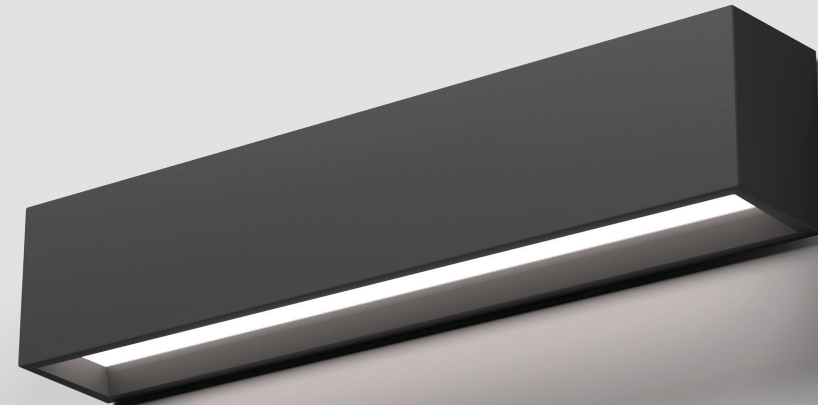

MRS. SMITH offers designers with a linear outdoor applique

that is similar in design and feel as the ZEDGE Family of products to provide designers with multiple options with a consistent look and feel.

LED
2700K / 3000K / 4000K

COLORS



MR. BO BOLLARD

A new BOLLARD family specifically designed for technical applications.

With a technically advanced design that delivers four different beam options in one modern design.

Contemporary and discreet for any application, its design is clean and modern.

This direct radial emission bollard is available in three heights and three color temperatures.

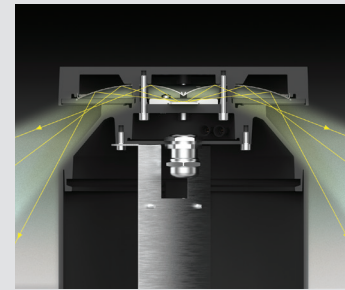

DIMENSIONS
6" Dia. 3 Heights: 16" / 32" / 40"

LED
2700K / 3000K / 4000K

DISTRIBUTION
360° / 180° / 90° / 90° + 90°

VOLTAGE
120-277V UNV

FINISH
■
IP67 cUL US

360° Distribution



180° Distribution

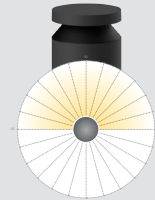

90° Distribution

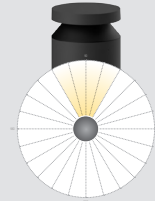

90°+90° Distribution

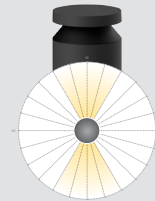

www.targetti.us

JUPITER MINI PROJECTOR

Miniature projector light.

An ultra-compact adjustable LED luminaire designed to deliver an aesthetically pleasing, yet durable solution for landscape and accent lighting. Its special design and construction details make it suitable for indoor or outdoor applications.

DIMENSIONS
1.5" Dia. x 2.8"H

WATTAGE
3W

LED
2700K / 3000K
3500K / 4000K

OPTICS
SP / FL / WFL

VOLTAGE
24V

COLORS
■
IP67 cUL US
Class 2



Coordinates with the **JUPITER Series** of miniaturized inground fixtures for decorative and accent lighting.

www.targetti.us





Boston Consulting Group, Los Angeles, CA
 Lighting Design: Oculus Light Studio
 Architect: Shubin & Donaldson
 Photos: ©Benny Chan/Fotoworks
 Awards: 2017 Lumen West – Award of Excellence – Interior Design



FOCUS ON YOUR TARGET

DBS
 Dynamic Beam Shaper

TARGETTI, with a wealth of successful experience in developing optical systems and meeting the different needs of the market in terms of design flexibility, is presenting a comprehensive offering of the first series of light fixtures fitted with innovative Dynamic Beam Shaper (DBS) technology. These are projectors with variable optics that can vary the beam opening using digital input without using any mechanical system.

DBS enabled fixtures are fitted with an optical system that can dynamically vary the beam opening angle passing in a gradual manner from a more concentrated SPOT (around 10°) type emission to a wider WIDE FLOOD (around 50°), flowing fluidly through all the all points in between. This technology based on the use of liquid crystal lenses makes it possible to vary the beam without using any mechanical or mobile parts but by using an IoT control system.



DYNAMIC BEAM SHAPING (DBS)



CCTLED DBS

As one of our most comprehensive and versatile solutions

for architectural lighting, the family of CCTLed has added another gem to its family - CCTLED DBS. Particularly suitable for professional architectural illumination, providing high performance, precision and versatility, the CCTLED DBS delivers one powerful with beam shaping technology to enhance this expansive downlight family.

DIMENSIONS

6" Dia. Aperture

LED

2700K / 3000K / 3500K / 4000K

OPTICS

DBS (Dynamic Beam Shaping - SP thru WFL)

WATTAGE

29W

TRIM FINISHES



CCTLED Mini DBS coming soon



CCTLED Family

This broad family provides a full offering of versatile distributions, interchangeable reflectors and trims to answer individual "architectural" project requirements and light engineering.

Available as both fixed and adjustable, in two different aperture sizes: mini 4" and large 6".

TRIM FINISHES



CLOUD DBS

CLOUD range offers different solutions

in terms of size, lumen packages, color temperature and beam spreads to cover a wide range of installations. The versatile CLOUD Series is now available with DBS technology to provide the ultimate in optic selections.

DIMENSIONS

6" Dia. Aperture

OPTICS

DBS (Dynamic Beam Shaping - SP thru WFL)

LED

3000K / 4000K

WATTAGE

39W

FINISHES



CLOUD Family



CLOUD MINI coming soon



DIMENSIONS

CLOUD 6" Dia.
CLOUD MINI 4" Dia.

WATTS

9W to 38W

LED

3000K / 4000K

OPTICS

DBS (Dynamic Beam Shaping - SP thru WFL)

CORO DBS

A compact projector designed specifically for high intensity LED projection

that is now available with DBS technology. CORO's optical body can adjust +/- 165° horizontally and +/-180° vertically with aim locking with a single knob for the two free degrees. It features an articulated arm that is adjustable +/-180° vertically and is available in two lengths. The powerful optics and versatile mounting accessories make CORO an ideal choice to illuminate objects on display with precise, clean beams.

DIMENSIONS

9.68" H / Short Arm
10.87" H / Long Arm

LED

3000K

OPTICS

DBS (Dynamic Beam Shaping – SP thru WFL)

CORO Family

CORO Large:
34W (SP 13° , FL 33°) / 39W (MWFL 43°)

CORO Large DBS:

39W DBS (Dynamic Beam Shaping – SP thru WFL)

FINISHES



ZENO / ZENO DBS / ZENO APPLIQUE

ZENO is versatile fixture with a modern design that works seamlessly

in both track lighting and wall mounted applications. Choose different optics for different lighting effects from our standard ZENO to our ZENO DBS. Choose from precise and defined light to a wall washer effect to “splash” wide vertical surfaces. ZENO's track projector is equipped with an optical system that can offer standard optics or vary the beam opening in a dynamic way passing gradually from a concentrated Spot type emission (around 10°) to Wide Flood (around 50°) moving through all steps in between fluidly with our DBS technology.

ZENO



DIMENSIONS

5.28" DIA. Aperture
x 8.58" H

WATTAGE

18W / 26W

LED

3000K / 4000K

OPTICS

NSP / SP / FL / MWF / WF

FINISHES



ZENO DBS



DIMENSIONS

5.28" DIA. Aperture
x 8.58" H

WATTAGE

29W

LED

3000K / 4000K

OPTICS

DBS (Dynamic Beam Shaping – SP thru WFL)

FINISHES



ZENO APPLIQUE

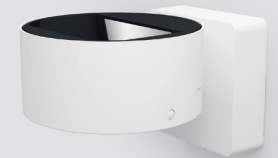

Adjustable wall mounted fixture with asymmetric optic, particularly suitable for lighting vaulted ceilings

DIMENSIONS

5.28" W x 8.58" H

WATTAGE

26W

LED

3000K / 4000K

OPTIC

Assymetric

FINISHES





Piazza Riccardo Cattaneo, 152, 10135
 Torino TO, Italia
 Architect: GTP - Gruppo Thema Progetti
 Photos: ©Antonio Ciddio



RAY MICRO

TARGETTI's RAY MICRO features a powerful LED track projector that is adjustable from 0° -90° on the vertical plane and 359° on the horizontal plane.

These fixtures, with an essential, simple design, produce different effects with a choice in optics that enable precise light beams with a Spot or Medium Wide Flood that highlight objects or architecture in a skillful contrast of light and shade. Featuring die-cast aluminum construction, the versatile track projector features a mechanical friction lock and aiming system that ensures the center of gravity always remains in axis with the track regardless where it is aimed. Available in 3000K and 4000K with dimming and track options.

DIMENSIONS
 3.0"W x 4.33"H x 3.50"D

WATTAGE
 14W

OPTICS
 SP / MW

LED
 3000K / 4000K

DIMMING
 Phase

TRIM FINISHES



OZ

OZ is TARGETTI's new, user friendly,

48V modular system that provides designers with a versatile, modern, and compact track lighting system. The complete OZ range offers a customizable system that will provide a choice of five installation options from recessed to suspended with "power track only" or with profile and track combinations. The compact system features a power track that is less than 1" W x 0.16"H with full modules measuring only 2.17" in height. The easy to use system features mechanical and electrical connections that are installed with magnets.

One system - Multiple options.



OPTICS
SP / FL / WF

MOUNTING
Track Mount / Surface

VOLTAGE
48V DC

TRIM FINISHES

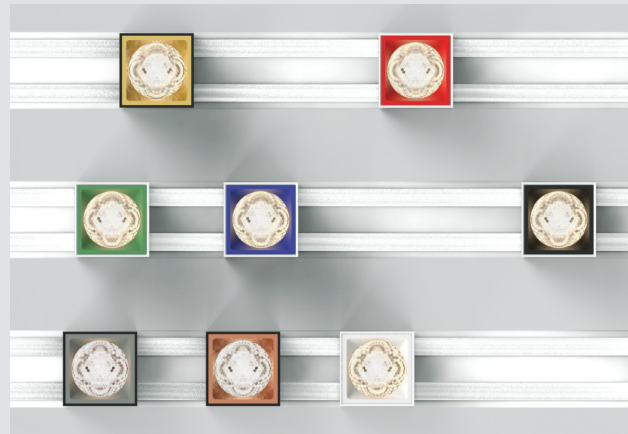

Secondary Reflector available in **COLOURS**

OZ System Components

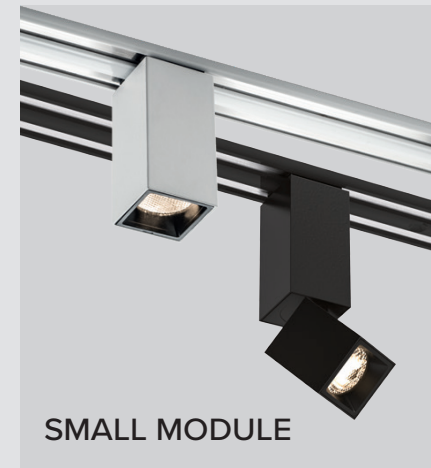

MODULE
Fixed / Adjustable

DIMENSIONS
0.98"x 0.98"

LED
2700K / 3000K / 3500K / 4000K

OPTICS
SP / FL / WF

MOUNTING
Combine in groups of up to 5
Adjustable Orientable Profile



MODULE
Fixed

DIMENSIONS
1.97"x 1.97"

LED
2700K / 3000K / 3500K / 4000K

OPTICS
SP / FL / WF

MOUNTING
Combine in groups of up to 3

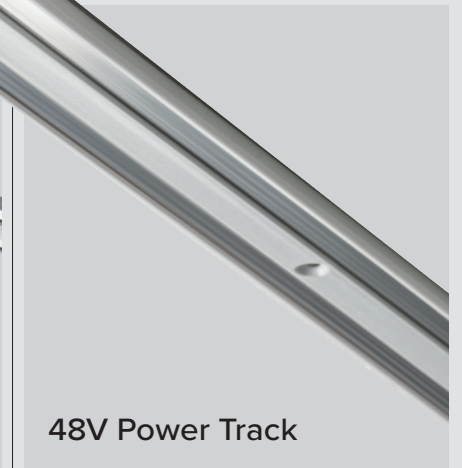

DIMENSIONS
2ft / 4ft / 8ft

CONNECTIONS
L / T / X

MOUNTING
Surface / Recessed

VOLTAGE
48V DC



Lido House Hotel – Newport Beach, CA
Lighting Design: First Circle Design
Architectural Design: WATG
Developer: R.D. Olsen Development
Photos: ©SAC Design



TOP FLEX PROFILE



SIDE FLEX PROFILE

DURAFLEX ARCHITECTURAL

Energy efficient flexible LED light for continuous consistent color in applications.

Extremely flexible linear LED with a flat lens profile that is available in adjustable lengths for varied architectural applications. Available in top-flex profile for arcing applications or side-flex profile. Ideal for IP66 location applications.

LED
2700K / 3000K / 35000K / 4000K

STATIC COLORS
Red / Green / Blue / Yellow / Orange

CONSTRUCTION
Extruded Silicone with Milky White diffusion lens

MOUNTING
Mounting Clips / Aluminum Channel Options



DURATAPE BIDIRECTIONAL



This multi-directional series

provides designers with the unique ability to illuminate both up and down distributions from the same linear compact tape.

DIMENSIONS

0.33" LED O.C Spacing
Max continuous length:
up to 16' per run

WATTAGE

4.4W/ft

LED

2700K / 3000K /
3500K / 4000K

CRI

95

VOLTAGE

24V DC

DIMMING

Remote 0-10V or
magnetic driver options



Private Residence, Huntington Beach, CA
Photos: ©SAC Design



Banc of California Stadium, Los Angeles, CA
Lighting Design: First Circle Design
Architect: Gensler
Photos: ©Henri Khodaverdi

DURATAPE ES

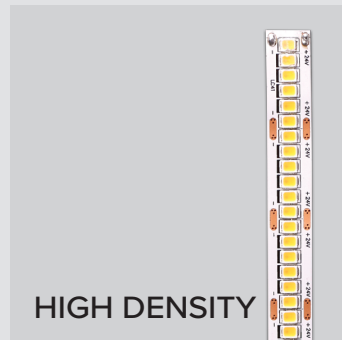

HIGH DENSITY

Tight spacing tape for shadowless light distribution.

DIMENSIONS
0.313" LED O.C Spacing
Max continuous length:
up to 16' per run

WATTAGE
5.8W/ft / 4.0W/ft

LED
2700K / 3000K
3500K / 4000K

CRI
95

DIMMING
Remote 0-10V or magnetic
driver options

VOLTAGE
24V DC

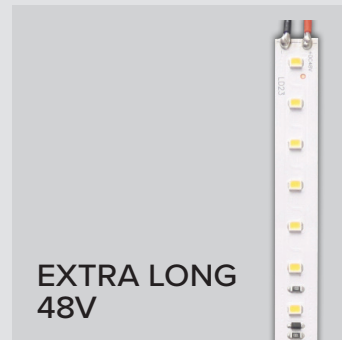

EXTRA LONG
48V

Achieve long distances with
this tape designed to double
your run length.

DIMENSIONS
0.47" LED O.C Spacing
Max continuous length:
up to 164' per run

WATTAGE
1.7W/ft

LED
2700K / 3000K / 3500K /
4000K

CRI
95

DIMMING
Remote 0-10V or magnetic
driver options



The expansion of our most sought after Tape Light

now features an expanded selection of additional wattages and color temperatures. Providing you with more options designed to meet requirements for specific applications, this Title 24 compliant tape works with our full set of profiles and channels for the ultimate in design flexibility and features advanced LED binning with +/- 2-step MacAdam ellipses.

Photos: ©SAC Design



www.targetti.us

www.targetti.us

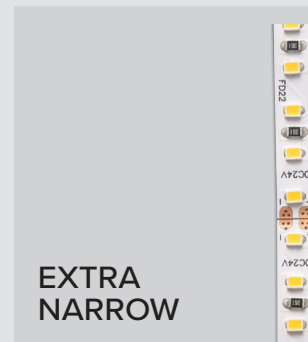

EXTRA
NARROW

Ultra slim profile and small width
for tight and small spaces.

DIMENSIONS
0.22" LED O.C Spacing
Max continuous length:
up to 16' per run

WATTAGE
2.2W/ft

LED
2700K / 3000K
3500K / 4000K

CRI
95

DIMMING
Remote 0-10V or magnetic
driver options

VOLTAGE
24V DC

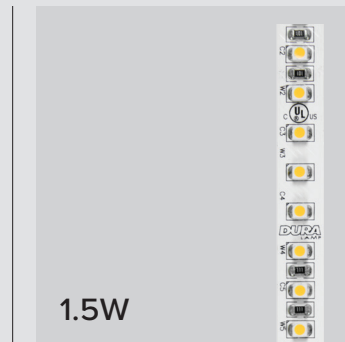

1.5W

A new standard added to our
current offering of ES selections.
Features same spacing and color
temperatures and now fully family
is available in 1.5W / 3.0W / 3.9W /
4.4W / 8.8W.

DIMENSIONS
0.33" LED O.C Spacing
Max continuous length:
up to 30' per run

WATTAGE
1.5W/ft

LED
2200K / 2700K
3000K / 3500K / 4000K

CRI
95

DIMMING
Remote 0-10V or magnetic
driver options

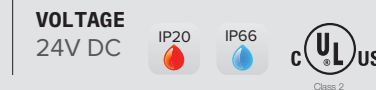

DURATAPE RGB SLIM

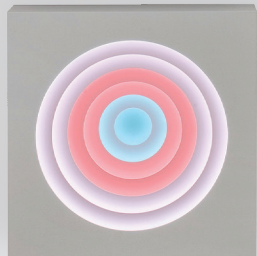
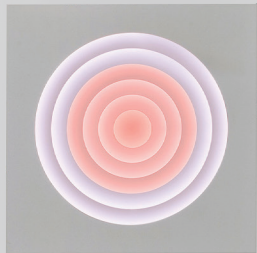

When a touch of color is needed

in tight spaces, Duratape RGB Slim provides a versatile solution. Providing you with more options ideal for high brightness and high density applications.

DIMENSIONS

0.24"W
Max continuous length:
up to 9.8' per single run

WATTS

4.4W/ft

COLOR

RGB Tri-Chip

VOLTAGE

24V DC



DURATAPE NEW CHANNELS

Our enhanced line of channels

provides an even broader and versatile selection to choose from. Enjoy a versatile selection from compact, slim, surface, adjustable, recessed, walk over, plaster in, decorative suspension profiles and a wall profile with double emission. A full selection for a variety of needs.



SLIM PROFILES

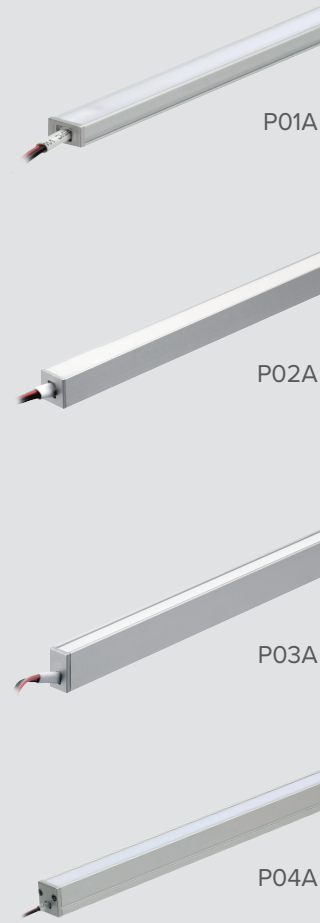

SURFACE PROFILES



ADJUSTABLE PROFILE



ASYMMETRIC PROFILE



PLASTER IN PROFILES

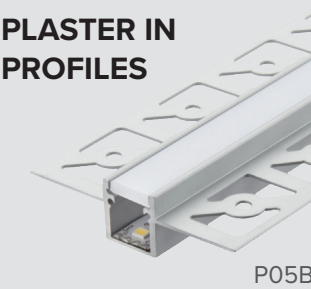

RECESSED PROFILES



WALK OVER PROFILE



DECORATIVE SUSPENSION PROFILES

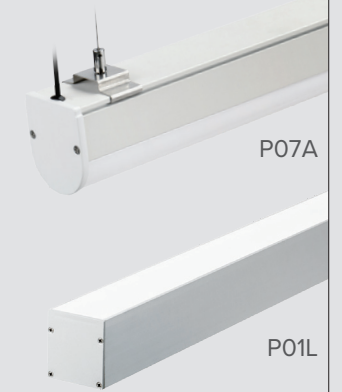

WALL PROFILE WITH DOUBLE EMISSION



MICROLINI

MICROLINI features a small profile linear LED flexible strand

that provides multiple uses and applications such as coves, undercabinet task and directional tasklighting. The flexible segmented strand system, comprised of compact round modules, can be bent horizontally up to 180° and 45° vertically from the next module for complex cove and niches applications.

It comes in 12" increments of 4 modules with an extruded aluminum round body with an opal lens cover and aluminum end caps.

DIMENSIONS

2.25" Segmented Modules

WATTAGE

4W/ft

LED

2700K / 3000K / 4000K

DIMMING

Remote 0-10V or magnetic driver options

VOLTAGE

24V DC

MOUNTING

Fixed stainless steel mounting clips available in 0°, 15°, 30°, 45° angles



Shown for curved installation



Shown for linear straight installation



MINILINI

MINILINI offers designers with a new compact linear line voltage projector

that is ideal for cove and indirect cove applications. Available in a 4W or 16W version with internal Flood optics of 90° X 120° in two popular lengths. Built with PCB integral DOB (driver on board) technology with surge protection. Cabled with SJO 18-3 cable and input/output watertight IP67 Quick Disconnect connectors.

DIMENSIONS

1.57"H x 1.59"W

Two Lengths: 12" / 24"

WATTAGE

4W/ft / 16W/ft

LED

2700K / 3000K / 4000K

DIMMING

ELV Reverse Phase Dimmable / optional 0-10v to ELV dimming converter available

OPTIC

FL with Clear or Opal Lens

VOLTAGE

120V AC / 50/60Hz

MOUNTING

Multiple adjustable short and long rotational brackets / fixed stainless steel mounting clips available in 0°, 15°, 30°, 45° angles

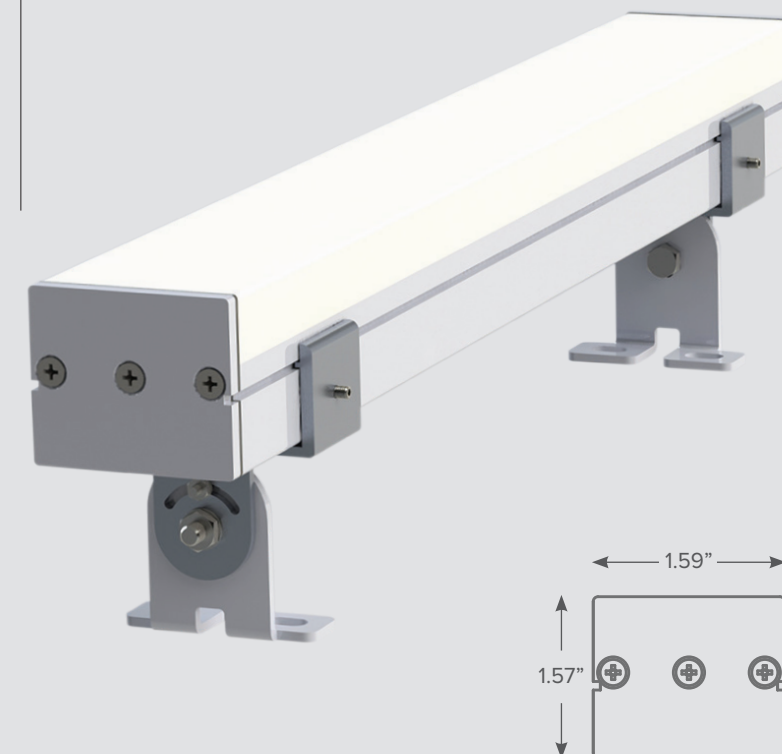

DECOLED TECHNO VINTAGE

Duralamp is proud to offer a new Retro style lamp to its popular DecoLED retro filament style LED lamp family

This vintage lamp series delivers today's LED technology in an energy efficient lamp with a classic look but modern output and efficiencies. The series is fully dimmable and available in a variety of lamps from 4W to 8W. The addition of the Mirror Bottom G95 with a soft filament provides up to 800 lumens with high efficacy of up to 60Lm/W. The full DecoLED Techno Vintage Series is now available in six distinct styles.

WATTAGE
8W (60W replacement)

BASE
E26

LED
2700K

BEAM ANGLE
280°

NOW Available in 6 Styles:

- G95 Model (3.74"D x 5.51"H)
- G25 Model (3.25"D x 4.6"H)
- S21 Model (2.28"D x 5.12"H)
- T10 Model (2.52"D x 5.51"H)
- A60 Model (1.10"D x 7.38"H)
- CANDLE (1.3"D X 3.9" H)



Use with DuraCable for indoor or outdoor use

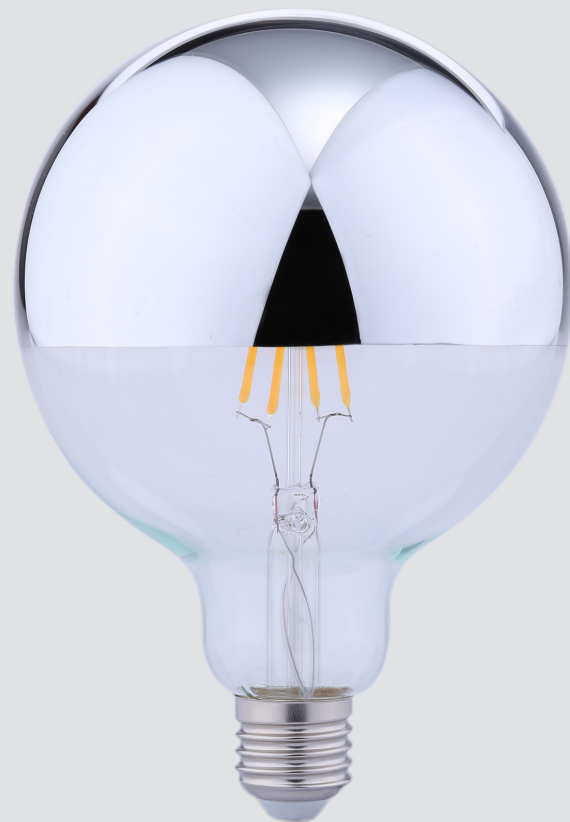

G95 Mirror Bottom with Soft Filament



CALYPSO



KEPLERO



SATURN



ZEDGE

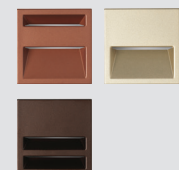

CHIODINO



MINI MERCURE

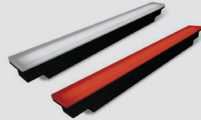

STILO WALL



ZEDGE LINE

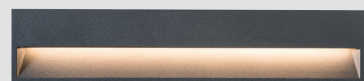

DART



MR. BO



STILO BOLLARD



FEBO EVO



MR. SMITH



TITANO LED



ZEDGE PRO



JEDI /
JEDI COMPACT

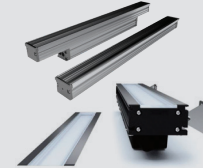

MRS. SMITH

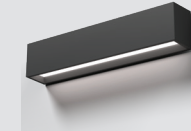

ZEDGE PRO
BOLLARD

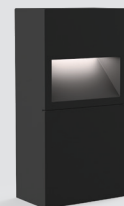

JUPITER



PYROS



5300 McConnell, Playa Vista, CA
Lighting Design: Oculus Light Studio
Architect: Shubin+Donaldson Architects
Photos: ©Henri Khodaverdi



Lugano Diamonds, Aspen, CO
Lighting Designer: First Circle Design
Photos: ©Michael Hefferon



CCT LED



CLOUD



CORO



DECANTER



ERCOLE



LEDO



OZ



PANTHEON



RAY MICRO



STORE



THREE SIXTY

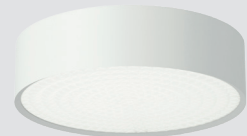

ZENO



BALLSTRAND

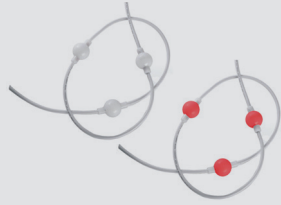

DURAFLEX NEON



DURATAPE



MATRIX LAMPS



DECOLED AURORA



DURALED CABLE



DURATAPE NEW CHANNELS



MICROLINI

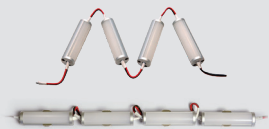

DECOLED PRISMA



DURALED STARGAZER



DURATAPE 120V



MINILINI



DECOLED TECHNO VINTAGE



DURALUM



INTELLISTRAND



THE TONES COLLECTION



Boston Consulting Group, Los Angeles, CA
Lighting Design: Oculus Light Studio
Architect: Shubin & Donaldson
Photos: ©Benny Chan/Fotoworks
Awards: 2017 Lumen West – Award of Excellence – Interior Design

TARGETTI

DURA LAMP

3F Filippi | **TARGETTI**

3F Filippi and Targetti, two companies that have shaped the history of lighting in Italy, are now embarking on a new venture with an ambitious common goal: to be the sole partner for lighting professionals and designers looking for quality solutions for all their project requirements. By combining their respective expertise in technical and architectural lighting the two brands together provide a complete portfolio of products that proudly take Made in Italy technology to more than 50 countries worldwide.

Today the 3F Filippi-Targetti Group can meet and satisfy any kind of design and project requirements. Our partners can choose from a huge selection of products and solutions; from high-tech and functional products from the 3F Filippi catalogue to indoor and outdoor architectural lighting fixtures designed by Targetti, right up to a wide range of LED lamps and fixtures from the Duralamp brand.

Targetti USA

750-A W. 17th St.
Costa Mesa, CA 92627
Phone: (714) 513-1991
targettiusa@targetti.com
www.targetti.us

Copyright © 2019 Targetti USA
v1.0