



Targetti Group is one of the most respected and recognized manufacturers of sophisticated architectural lighting solutions for the international lighting community. Targetti USA offers a wide range of products suitable for many different applications and are characterized by a high level of quality, design, functionality, performance and compliance with North American standards including UL/ETL, ADA, Title 24, NEC. Every Targetti product expresses the values the company holds dear. On one hand perfect light control and excellent performance, and on the other extreme attention to aesthetic detail. We cater to designers to provide flexible solutions that can meet even the most complex aesthetic and functional needs.

3F Filippi and Targetti, two companies that have shaped the history of lighting in Italy, are now embarking on a new venture with an ambitious common goal: to be the sole partner for lighting professionals and designers looking for quality solutions for all their project requirements. By combining their respective expertise in technical and architectural lighting the two brands together provide a complete portfolio of products that proudly take Made in Italy technology to more than 50 countries worldwide. Today the 3F Filippi-Targetti Group can meet and satisfy any kind of design and project requirements. Our partners can choose from a huge selection of products and solutions; from high-tech and functional products from the 3F Filippi catalogue to indoor and outdoor architectural lighting fixtures designed by Targetti, right up to a wide range of LED lamps and fixtures from the Duralamp brand.

TARGETTI

3F Filippi | **TARGETTI**
DURA
LAMP



Los Angeles Football Club
Lighting Designer: First Circle Design

Architect: Gensler
Photos: © Henri Khodaverdi

Bulletto / Bulletto Mini

Adjustable Flood Light Projector



A

Bulletto
6.51" X 1.95" Ø



B

Bulletto Mini
6.28" X 1.56" Ø

The **Bulletto Series** is a compact adjustable flood light projector design that fits easily into

any environment and offers a versatile array of lumen and output in two sizes.

A Bulletto

Voltage	Wattage	LED	Optics	Driver	Finish	
24V	10W: NSP only 12W: SP • NFL • FL • MWF	2700K 3000K 3500K 4000K	NSP SP NFL FL MWF	Remote	Ferrite Bronze	IP66 cULus Class 2

B Bulletto Mini

Voltage	Wattage	LED	Optics	Driver	Finish	
24V	8W	2700K 3000K 3500K 4000K	SP FL MWFL	Remote	Ferrite Gray Bronze	IP66 cULus Class 2



→ Fixture design allows for ease of attachment to received mounting. Available with a wide range of installation accessories ranging from surface mount canopy, rotational plate, ground stake, and tree strap assembly. With use of 1/2" NPT treaded base, fixture can easily be incorporated to a pole mount installation.



- This compact projector flood light is suitable for high intensity applications. Available in two different diameters 1.5" and 2" with a range of optics and aesthetically coordinated accessories.
- Equipped with a bass strain release gland with 1/2" NPT thread that can be screwed directly to the receiving mounting. It is adjustable up to 180° on the vertical plane with an aim locking set screw.
- For use in marine grade environments.



- Containing three elements in a single projector: the base; the central body, which is the heart of the system, and physically isolated from the other elements and test independantly; the optical compartment allowing for varied beams by replacing different holographic filters and accepting media.
- This compact design features 24V Class 2 remote driver power options. The **Bulletto Series** provides an ideal solution for precise, efficient accent lighting.

Coming Soon: Bulletto Line Voltage

Voltage	LED	Optics	Driver	Finish	
Universal 120-277V	2700K 3000K 3500K 4000K	NSP SP NFL FL MWF	Integral 0-10V	Ferrite Bronze	IP66 cULus

Zedge Line Opal

Recessed Linear Steplight



12" x 2.50" x 2.05"

The Zedge Line is a compact linear recessed wall mounted LED steplight with the versatility to be installed in both indoor and outdoor applications. Zedge Line is the slim and slender

version of the Zedge, available in the new Opal lensed version for softer and more diffuse illumination.

Designed in collaboration with Gensler

Voltage	LED	Optics	Driver	Finish
24V Universal 120-277V	2700K 3000K 3500K 4000K	VWFL	Remote Integral 0-10V	● Ferrite (metal frame)
				IP66 UL US

Zedge Bollard

Small Scale Bollard



2.52" x 2.52" x 16"

Zedge is a steplight marker with a minimal design and compact size (2.5" x 2.5"). The design has been reduced its core with its minimal proportion and nuanced scale. Now available as a small scaled bollard luminaire designed to bring the wall illumination into the landscaping environment.

The relationship between the vertical face and angled illuminated surface defines a discrete product that creates a strong architectural statement.

Designed in collaboration with Gensler

Voltage	LED	Optics	Driver	Finish
24V Universal 120-277V	2700K 3000K 3500K 4000K	Floor Washer	Remote Integral 0-10V	● Ferrite
				IP66 UL US

Mr Smith / Mrs Smith

Surface Mounted Direct/Indirect Wall Sconce

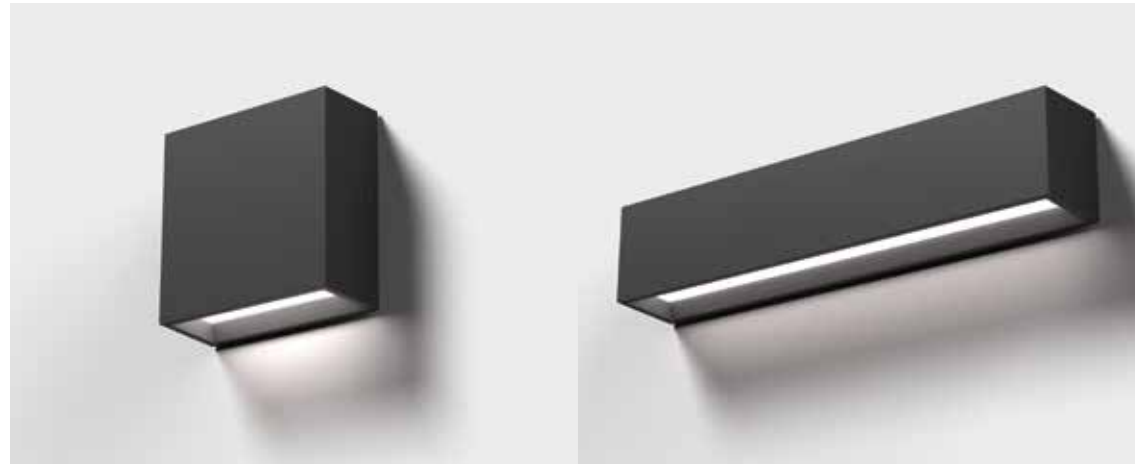

A

Mr Smith
5.12" x 5.12" x 2.03"

B

Mrs Smith
12.01" x 2.50" x 2.03"

New range of wall mounted fixtures for outdoor applications with a minimalist design and small footprint. Designed to mount alongside the Zedge Series with their proportions similar and attention to detail. Available in two different shapes: square for Mr Smith and rectangular for Mrs Smith.

- Both versions are available in three different emissions: direct, indirect, or direct/indirect. With a soft beveled opening at the bottom together with the opal polycarbonate screen, softly accompanies the light recalling the design of the Zedge Series; where in the version with only indirect or direct/indirect emission uses a polycarbonate screen at the top softly diffusing the light.
- Features no visible screws or hardware for an overall clean mounting.

Voltage	LED	Optics	Driver	Finish
Universal 120-277V	2700K 3000K 4000K	Direct Indirect Direct/Indirect	Integral 0-10V	Ferrite IP66 UL US

Jedi Compact Recessed

Recessed Linear Ingrade



↗

4 lengths:

- L 12"
- L 24"
- L 36"
- L 48"

The Jedi Compact is a new family originating from our popular Jedi Series. Available in the new Jedi Compact Recessed IP67 linear inground with high performance and compact dimensions.

- Available with a remote driver in the 12" length only and with integrated driver for 24", 36" and 48" lengths. It is walk over rated. To be completed with an installation sleeve for flush inground mounting.
- Available in three optical distributions: Flood, Wall Grazing, and Wall Washer; optional integral Louvre available.
- Jedi Compact IP67 is also available as a surface-mount linear projector version for both outdoor and indoor installations.



Walk Over

Voltage	Wattage	LED	Optics	Driver	Finish
Universal 120-277V	12W 24W 36W 48W	2700K 3000K 3500K 4000K	FL Wall Grazing Wall Washer	Remote Integral 0-10V	Brushed Stainless Steel IP67 UL US

Jupiter / Jupiter Mini

Recessed Small Scale Ingrade



Newport North Retail Center – Newport Beach, CA
 Lighting Design: First Circle Design
 Photos: © SAC Design

Jupiter Series is a line of inground luminaires with lenticular optics that makes it possible to obtain defined, precise beams within a small body.

It is drive over rated now equipped with an optional integral anti-glare louver or asymmetrical screen. **Jupiter Mini** is also available in a compact adjustable projector flood light.



A
Jupiter
 3.15" Ø



B
Jupiter Mini
 2" Ø



+
Louver



+
Asymmetric Screen



Drive Over

Voltage	Wattage	LED	Optics	Driver	Finish (Stainless Steel)	
24V	3W 9W	2700K	SP	Remote	Brushed	
		3000K	FL		Bronze PVD	
		3500K 4000K	WFL		Gun Metal Black PVD	

Keplero Mini Wall Wash

Recessed 6" Ingrade







 6" Ø

Keplero Mini Wall Wash is a compact version with only a 6" in diameter. It takes it's the technology and flexibility from the larger version, but given its dimensions and high performance, is also suitable for external lighting such as building facades and signage.

The new generation in-ground LED light fixture for outdoor lighting. The **Keplero** series is complete range of recessed ingrade up-lights for outdoor lighting. Available in two different sizes (6" and 11" diameters) with a wide range of optics with static white LED sources or RGBW LED chips with different lumens are the expression of versatility and performance. **Keplero** is a powerful solution and the ideal choice for lighting large and small public spaces, building facades and trees given its' size and high performance.



Voltage	Wattage	LED	Optics	Driver	Finish (Stainless Steel)
Universal 120-277V	15W	3000K 4000K	Wall Washer	Integral 0-10V	<ul style="list-style-type: none">  Brushed  Bronze PVD  Gun Metal Black PVD

Keplero Mini HE Factory Sealed



Recessed 6" Ingrade





 6" Ø

Our Keplero Mini HE fixture is now available as a tamper proof factory sealed complete fixture, to be delivered as a sealed unit directly from the Targetti USA factory.



Voltage	Wattage	LED	Optics	Driver	Finish (Stainless Steel)
Universal 120-277V	15W	2700K 3000K 3500K 4000K	SP FL MWFL	Integral 0-10V	<ul style="list-style-type: none">  Brushed  Bronze PVD  Gun Metal Black PVD

Exterior Fixture

Marine Grade Option

Cataphoresis Treatment



Optional marine grade cataphoresis and painting treatment available, recommended for use between marine environments from the ocean shoreline to 1/2 mile inland.

→ With a corrosion protection level increase of 40%, this product is suited to inground installations in places close to the sea, unless the external coating is damaged and except for places with corrosive or oxidizing agents such as fertilizers, salt, weed-killers, pesticides.

→ Cataphoresis process is an electrodeposition of deep paint with continuous electric current. The deposited film gives the articles high anti-corrosion characteristics, extending over time the preservation of all the parts that are not reachable with a traditional spray system (boxed, deep folds, couplings between sheets).

A Marine Grade treatment available as option on:



Titano



Febo Evo



Pyros Series

- Pico
- Nano
- Pyros
- RGBW



Stilo Series

- Wall
- Path
- Raised



Dart Series

- Small
- Medium
- Large



Mr.Bo

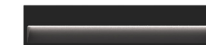

Zedge Series

- Bollard
- Pro
- Line
- Mini

B Marine Grade treatment available as standard on:



Mercure Series

- Mini Mercure
- Mini Mercure RGB



Keplero Series

- | | |
|---------------|---------------|
| Keplero | Keplero Mini |
| • Zoom | • Zoom |
| • Gimbal | • Gimbal |
| • Gimbal HP | • HE |
| • Wall Washer | • Wall Washer |
| • RGBW | |



OZ

Modular Magnet Mounted 48V System – Phase 2



The idea behind OZ came from the desire to create a system that is decisive as well as simple and minimal. A system that designs and illuminates the space with its modules and form.

OZ is the new magnetic 48V system: versatile, intuitive and easy to install with which it possible to create multiple configurations using special connections and different fixing systems. Free shapes to create on the ceiling, wall and suspension with the use of a power track or with special channels that can also be recessed. The system is fitted with magnetic LED light modules in two different fixed and adjustable versions.

The heart of the system is the power track, an advanced conductive track, 0.2" thick, that unwinds through the space, bringing 48V of power and on which the lighting units, which are available in various beam angles, are hooked using magnets. The system can be left visible for surface installations, highlighting its lightness and technology, or built into the profiles for installation on surfaces, as suspension, or recessed.

The new OZ 48V magnetic system is already the subject of study and analysis to extend its design flexibility. Now the large 2" x 2" light fixture module will also be available in an adjustable version.



A

OZ Small Adjustable
1" x 1" x 3.35"



B

OZ Large Adjustable
2" x 2" x 4"

A B

Voltage	Wattage	LED	Optics	Driver	Finish	
48V	9W: (SP)	2700K 3000K 3500K 4000K	SP FL MWFL	Remote Driver	○ Plaster White ● Deep Black	IP20 cULUS Class 2
	10W: (FL • MWFL)					

Coming Soon:
OZ DBS Option



C

OZ Small 48V 5X
5" x 1" x 2"

D

OZ Large 48V 3X
6" x 2" x 2"

C D

Voltage	LED	Optics	Driver	Finish	
48V	2700K 3000K 3500K 4000K	SP FL MWFL	Remote Driver	<input type="radio"/> Plaster White <input checked="" type="radio"/> Deep Black	



E

OZ Power Track Cover Ready
3.28ft (1M) • 6.59ft (2M)

F

OZ Power Track Cover Kit 5Pz
3.28ft (1M) • 6.59ft (2M)

G

OZ Magnetic Wall Ceiling Joint
2.6" x 2.6" x 0.35"

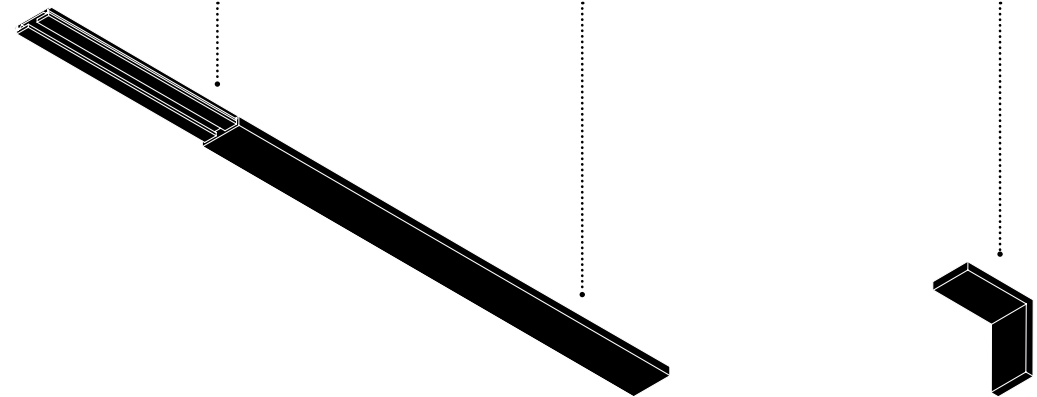

E F G

Finish	
<input type="radio"/> Plaster White <input checked="" type="radio"/> Deep Black	

Omega Surface Omega Suspended

Wall Mounted Sconce or Linear
Suspended Ceiling Fixture



A range of cylindrical diffused opal lensed luminaires provide 270° distribution that softly illuminates the space.

Designed in collaboration with Gensler

- Available in a range of sizes and forms developed for coordinating lighting in spaces for hospitality and for common areas.
- Available in ceiling-mounted, suspension and wall-mounted versions.

WALL-MOUNTED VERSION

The wall-mounted versions are available in two lengths and can be installed either horizontally or vertically. They are ideal for the lighting of common areas, stair wells and vanities, coordinated with the general lighting provided by the longer versions.

SUSPENSION VERSION

The suspension version has a single direct point of emission, supplied complete with suspension kit.

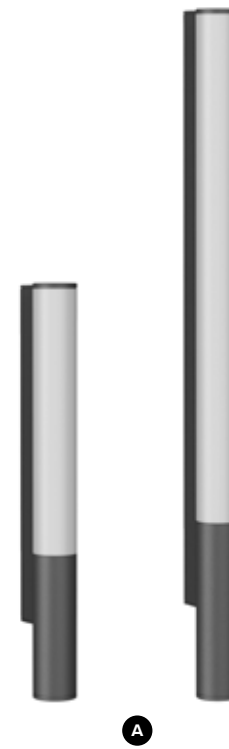

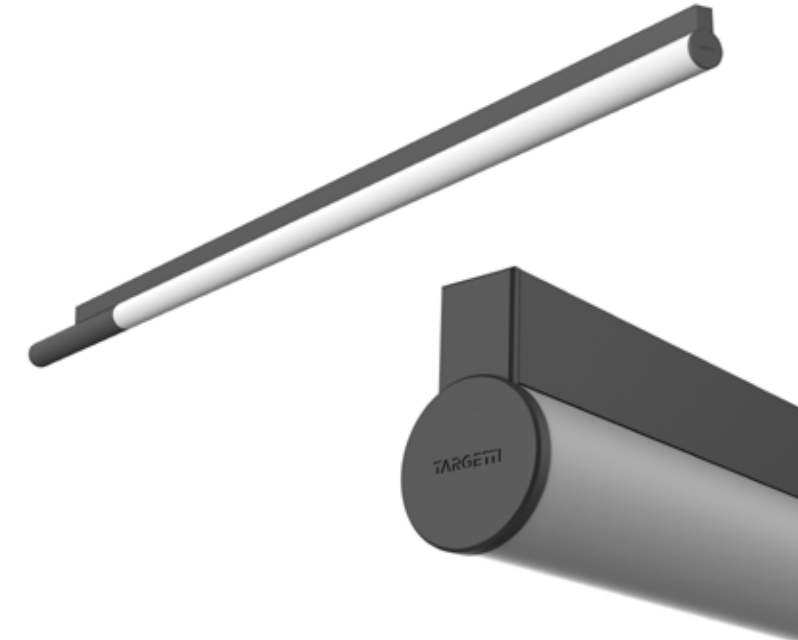

A

Omega Surface
L = 18.58" • L = 31.18"



B

Omega Suspended
L = 84.41"

Voltage	LED	Optics	Driver	Finish	
Universal 120-277V	2700K 3000K 3500K 4000K	Opal	Integral 0-10V	● Ferrite	 

Iso Suspended

Linear Suspended Ceiling Fixture



A new surface and suspension light for the office and hospitality environments. Available in one size (83.15" long) in a suspended version with direct lighting.

Designed in in collaboration with Gensler

The two different optical systems – Opal and UGR – make it suitable for installation in office applications which are increasingly becoming open spaces, and in Hospitality projects which require not only visual comfort, but also attention to design and detail. Also available in a ceiling-mounted version of the same length, for direct light only.

OPTICAL SYSTEMS

Opal

The diffused effect of Iso Opal is the result of a mirrored reflector with an opal lens. The light emitted appears soft and widespread, particularly suitable for reception areas in offices, hotels and spaces. In the direct/indirect light version, a line of light is present on the upper part, complete with diffusing lens to provide even light on the ceiling.



UGR

The UGR version is focused entirely on visual comfort. The color rendering index of CRI 90 and the perfect UGR lens. The sophisticated optical system, comprised of a mirrored reflector and prismatic lens, reduces the shadows and reflections that can cause disturbances on work surfaces. Ceiling-mounted and suspension versions.

DESIGN

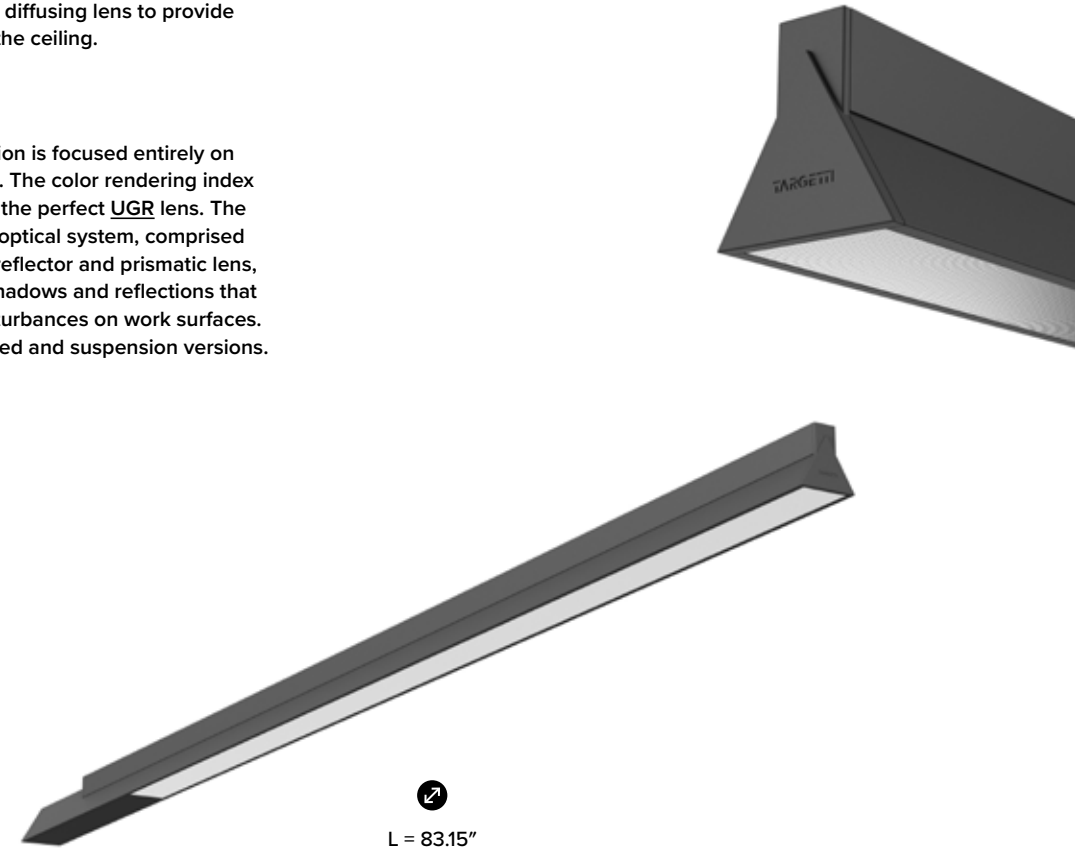
The union of two forms, has lead to the creation of a contemporary fixture that is both recognizable, yet discrete.



Voltage	LED	Optics	Driver	Finish	
Universal 120-277V	2700K 3000K 3500K 4000K	Opal UGR	Integral 0-10V	● Ferrite	 

Fortyeight Family

Magnetic 48V track system



A 48V modular system with variable lengths to be equipped with track projectors and linear light modules. The system that can be ceiling or wall surface and suspension mounted, fitted at any point with linear lighting fixtures due to its simple fixing system. It is minimal in size

1" in width by 1.13" x 0.65" – 3.28ft (1M) or 6.56ft (2M) in length. Uses a magnetic fixing system without the use of tools to attach fixtures at any point on the system. Wall mounted installation for effective easy lighting for example in retail spaces such as shop windows.



A

Fortyeight Multisystem Track
3.28ft (1M) • 6.59ft (2M)

A

Voltage	Driver	Finish	
48V	Remote Driver	<input type="radio"/> Plaster White <input checked="" type="radio"/> Deep Black	IP20 cULUS Class 2



B

Fortyeight Label 2
Ø 0.79"

C

Fortyeight Label 4
Ø 1.57"

D

Fortyeight Label 6
Ø 2.32"

Fortyeight Label (2, 4, 6)

48V track projectors available in three sizes, specially designed for applications in the retail, interior and hospitality fields. Minimal, simple shapes with a remote power supply to reduce visual impact to the minimum. Available with three different beam openings, SP, FL and MWFL. Label 4 (1.57" dia.) and Label 6 (2.32" dia.) track projectors are equipped with

aluminum reflectors to ensure soft gradient tones even for the narrower beams; the source is set back from the profile for maximum visual comfort. Label 2 features an optical system made of a polycarbonate lens and a holographic filter. Finally Label 2! The smallest adjustable 48V LED professional projector with a diameter of just 0.79".

B C D

Voltage	LED	Optics	Driver	Finish	
48V	2700K 3000K 3500K* 4000K	SP FL MWFL	Remote Driver	○ Plaster White ● Deep Black	IP20 cULus Class 2

* not available on Label 2

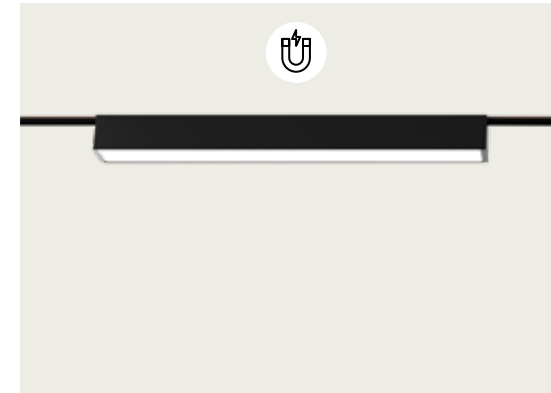

E

Fortyeight Logico 30

4 Lengths:

- L 12"
- L 24"
- L 45"
- L 78"



F

Fortyeight Logico 30
Corner: 12" x 12"

Fortyeight Logico 30

48V linear modules complete with opaline screens for a soft and diffused lighting effect. The system can be configured in various ways on plan thanks to the use of linear joints and the new corner joints that make it possible to create closed and open loops.

E F

Voltage	Wattage	LED	Optics	Driver	Finish	
48V	6W 2W 24W 42W	2700K 3000K 3500K 4000K	Opal	Remote Driver	○ Plaster White ● Deep Black	IP20 cULus Class 2

Zeno Applique

Wall Mount Indirect Sconce Asymmetric Distribution



7.60" x 8.28" x 5.75"

Zeno is a range of professional projectors especially designed for museum lighting, given the quality of the LED sources, the cutting edge optics and installation flexibility. The **Zeno Applique** uses a wall washer optic and is particularly suitable for

lighting vaulted ceilings and archways. The optical unit can be adjusted from 0 to -90° on the vertical plane; and 355° on the horizontal plane with aiming blocking system. **Zeno** is also available in the track projector version.



Voltage	Wattage	LED	Optics	Driver	Finish
Universal 120-277V	26W	2700K 3000K 3500K 4000K	Wall Washer	Integral 0-10V	<input type="radio"/> Plaster White <input checked="" type="radio"/> Deep Black

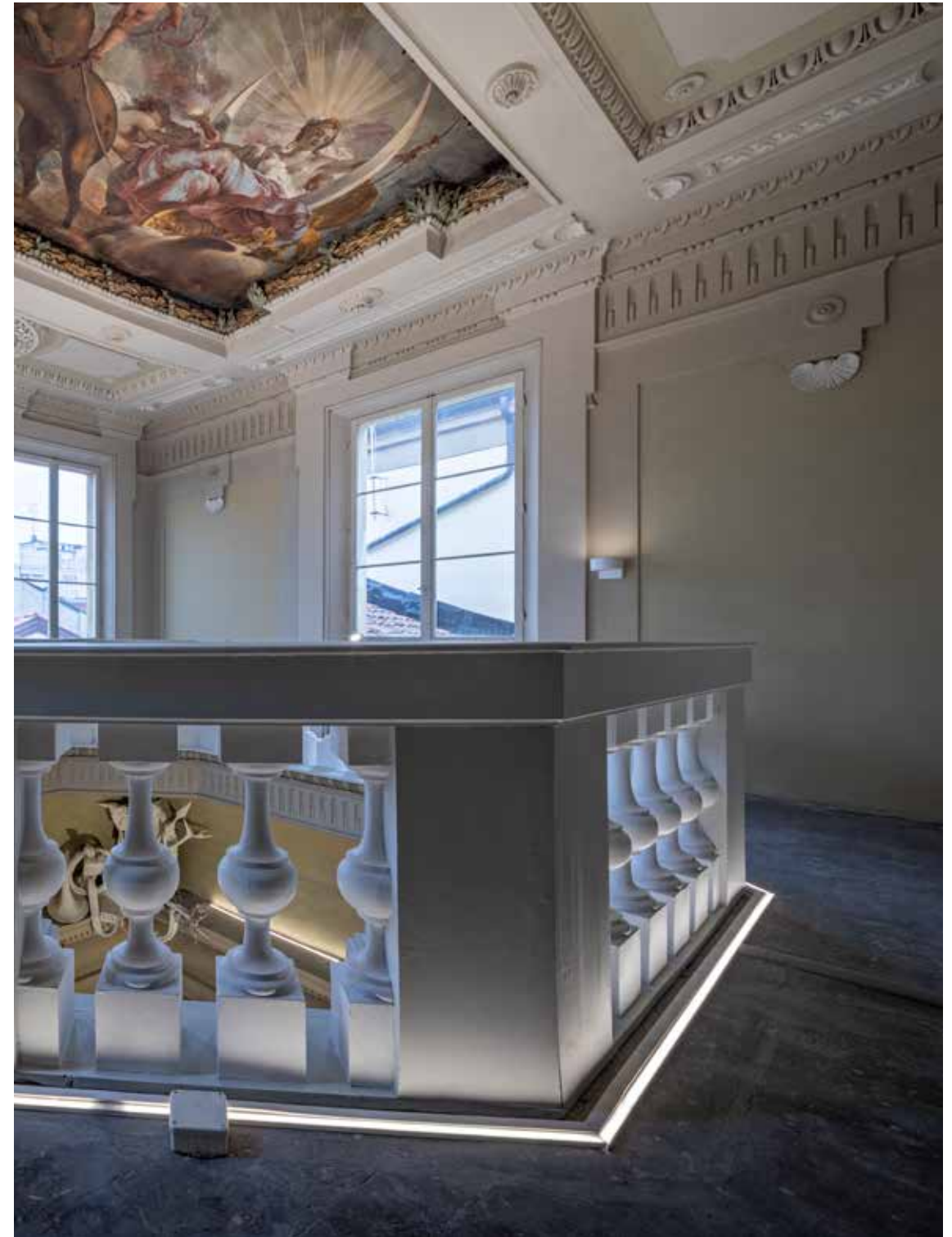

Merendoni Palace – Bologna, Italy
Photos: © Ivan Rossi



Lido House Hotel

Lighting Design: First Circle Design
Architectural Design: WATG

Developer: R.D. Olsen Development
Photos: © SAC Design



Duraflex 120V Dim To Warm



A line voltage led strip featuring built in dim to warm preset dimming curve technology to create an elegant incandescent atmosphere.



Voltage	Wattage	LED	Optics	Driver
120V	3.6W/FT	1800K-->3000K 2700K-->6500K Ra >90	120°	ELV dimmable



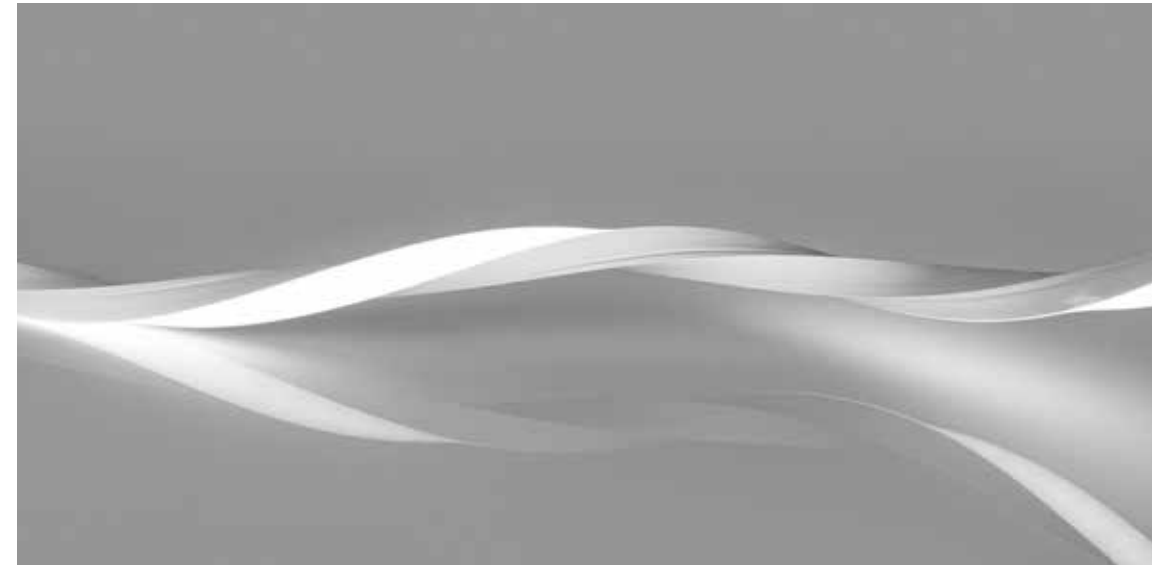

Duraflex Neon Twist



Fully twistable duraflex that is field cuttable at any length.

Voltage	Wattage	LED	Optics	Driver
24V	2.7W/FT	2700K 3000K 3500K 4000K	120°	Remote Driver



Mini Duraflex Neon



Direct view miniature sized linear duraflex neon with colored frosted lens, corresponding with led color for a saturated look.

For use in both illuminated and non illuminated signage elements and direct view applications. Field cuttable at any length.

Voltage	Wattage	LED	Optics	Driver
24V	2.7W/FT	3000K • 3500K 4000K • red • green • yellow • orange • blue • cyan • purple	240°	Remote Driver





Duraflex Optics



Linear led strip and imbedded optics all in one!

Voltage	Wattage	LED	Optics	Driver
24V	6W/FT	2700K 3000K 3500K 4000K Ra >90	A Wall Wash 120° X 60° B Wall Grazer 30°	Remote Driver

Duratape Full Spectrum

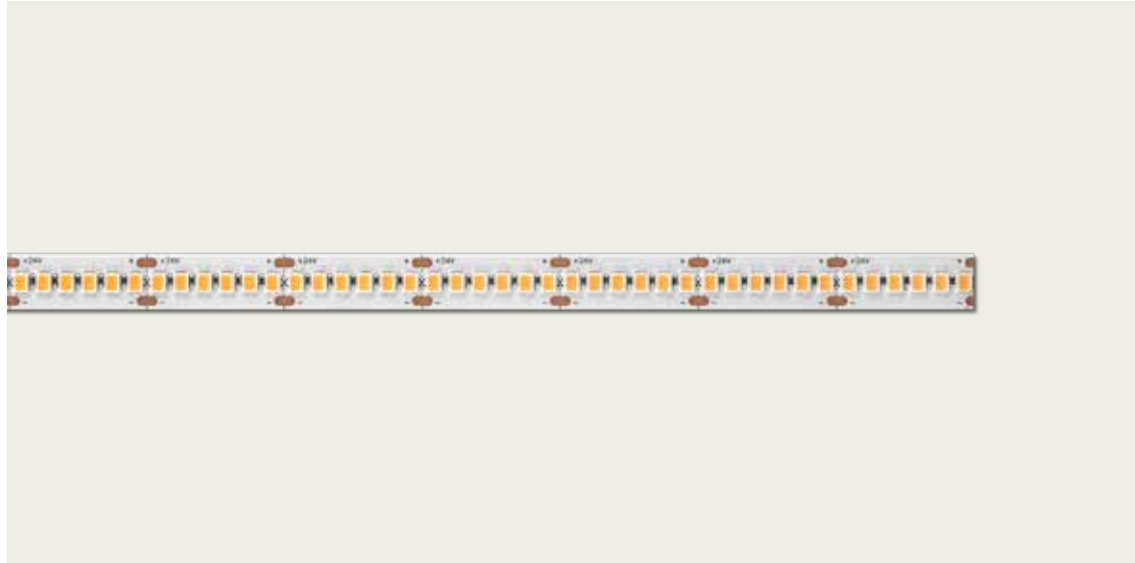

Full spectrum static white strip with perfect color rendition, CRI of +98, no color shift, and tighter spacing leds.

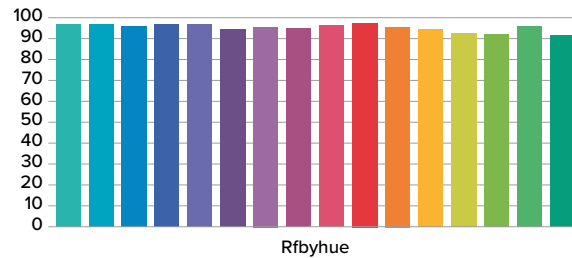
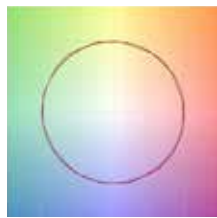

Voltage	Wattage	LED	Optics	Driver	
24V	2W/FT 4W/FT	2700K 3000K 3500K 4000K Ra >98 1 step mcdam binning	120°	Remote Driver	

Duratape Dim-To-Warm

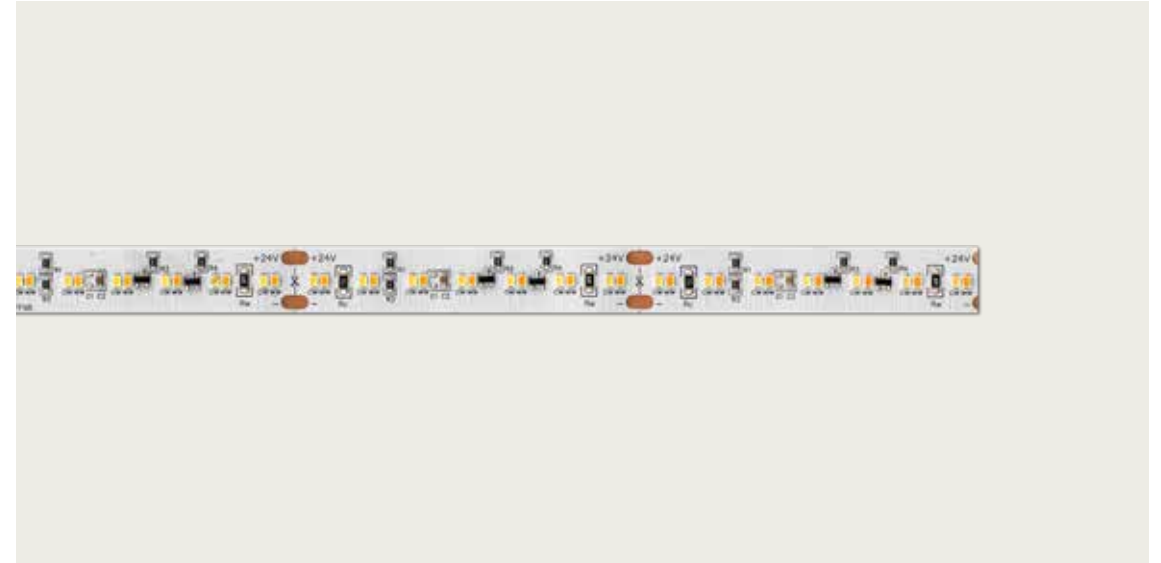

Dim to warm LED strip in ranges of 1800K–3000K and 2700K–6000K on a single circuit.

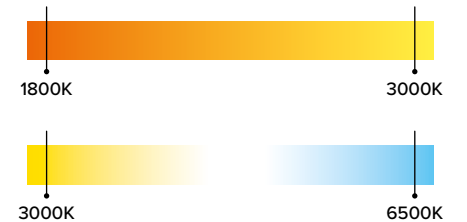

Voltage	Wattage	LED	Optics	Driver	
24V	2.9W/FT	1800-3000K 3000K-6500K RA >84	120°	Remote Driver	

Duratape PVX





PVX tunable flexible LED strip light for variable white color tuning allows the freedom to choose any warm white

color temperature from 1800K–3000K or any cool white color temperature from 3000K–6500K.



Voltage	Wattage	LED	Optics	Driver
24V	3.2W/FT	1800K-3000K 2700K-6500K RA >90	120°	Remote Driver



Duratape Extreme Tunable CCT

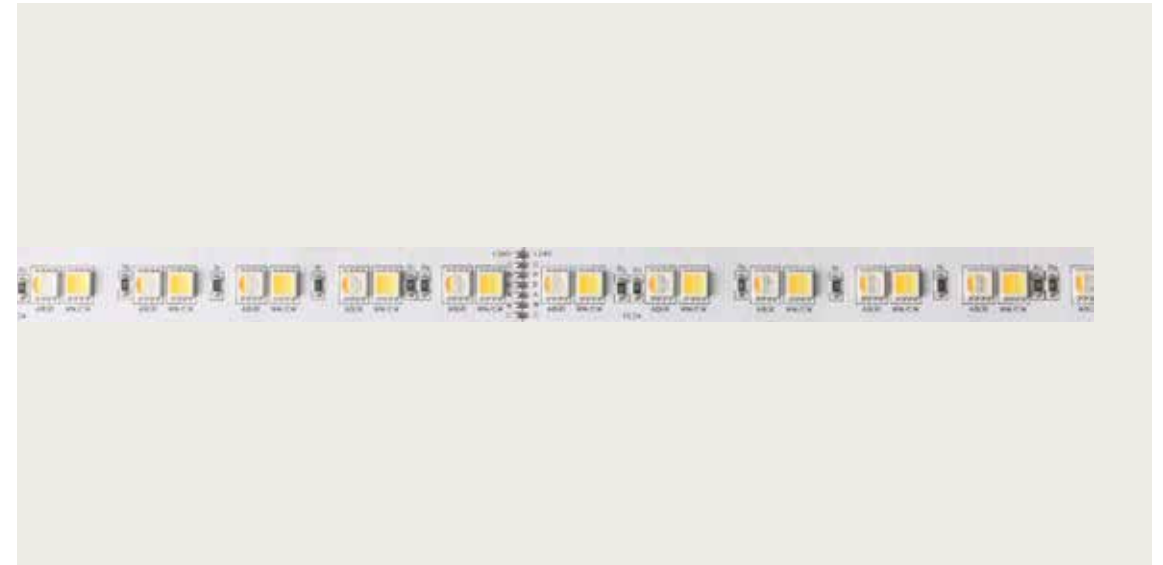

Color changing strip with both color tunable white and full spectrum dynamic RGBA all combined in one linear strip.

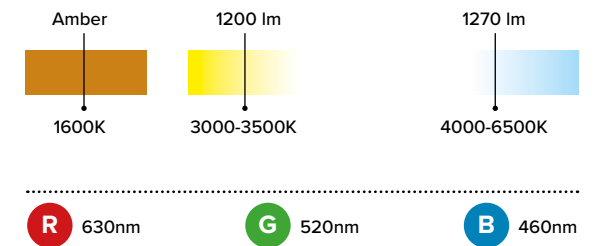

Voltage	Wattage	LED	Optics	Driver
24V	6.9W/FT	3000K-6500K RA >90 + RGB + amber (1600K)	120°	Remote Driver

Duratape Ultra HD RGB

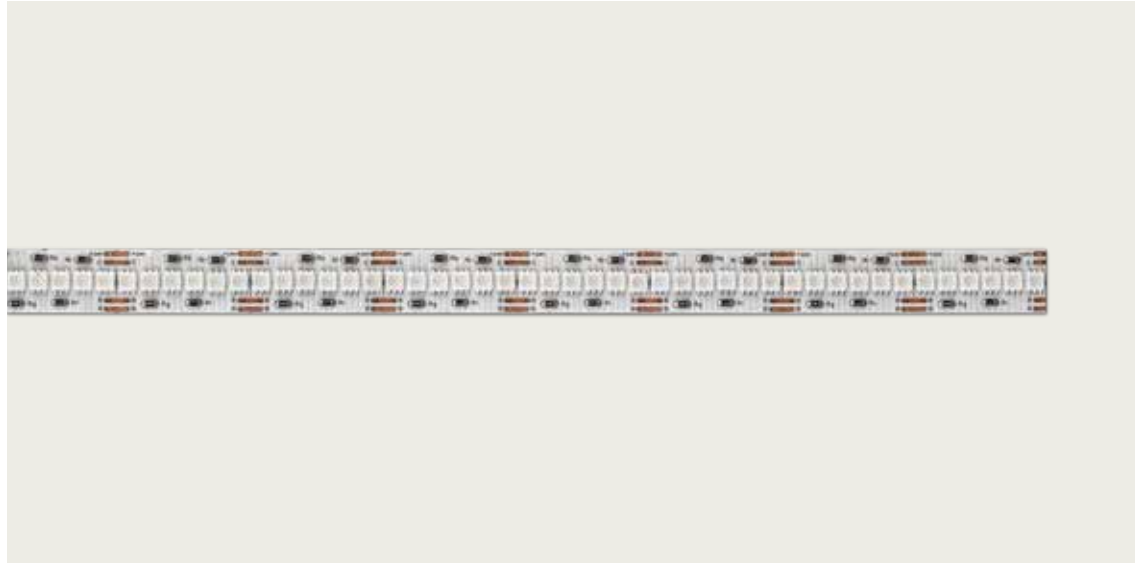

Dynamic colored rgb strip light featuring tighter spacing led sources with no pixelization to achieve shadowless light effects.

R 630nm **G** 520nm **B** 460nm

Voltage	Wattage	LED	Optics	Driver
24V	4.2W/FT	RGB	120°	Remote Driver

IP20

IP65

cULus
Class 2

Duratape RGB Pixel Control

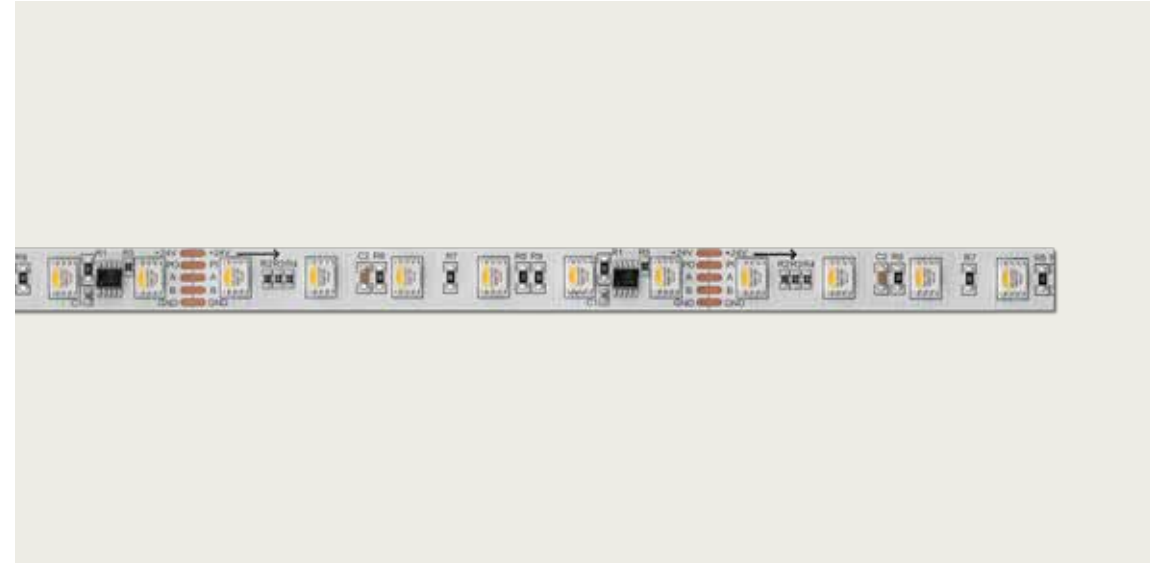

Dmx direct connect intelligent addressable 4" (6 LED) segments.

R 630nm **G** 520nm **B** 460nm

Voltage	Wattage	LED	Optics	Driver
24V	6W/FT	RGB	120°	Remote Driver

IP20

IP65

cULus
Class 2

Duratape S Bend

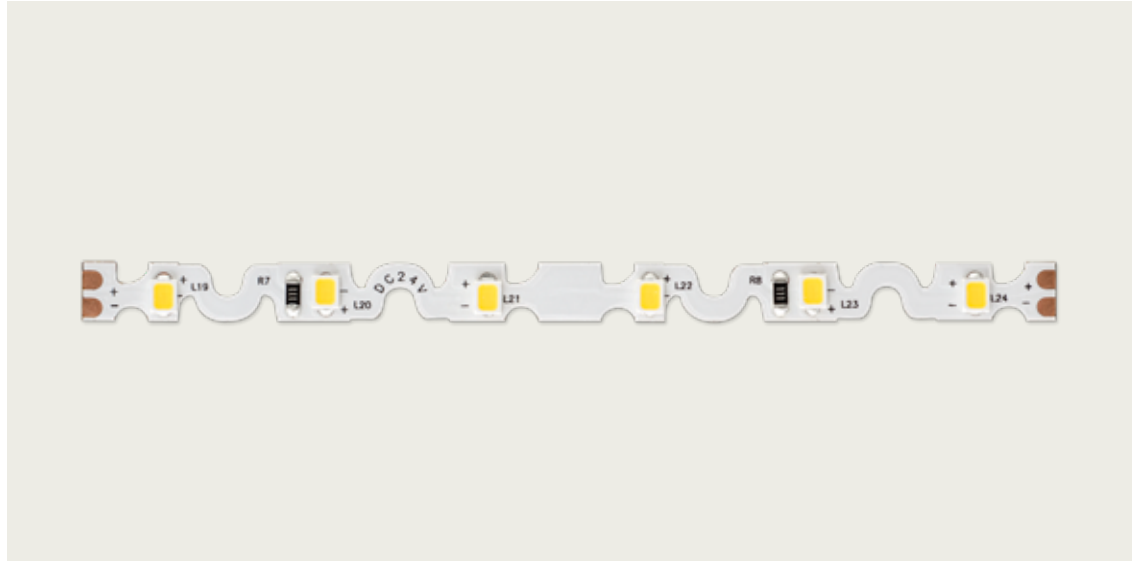

Bendable serpentine strip light for use with sign lighting and radius mounting applications.



Voltage	Wattage	LED	Optics	Driver
24V	2.2W/FT	2700K 3000K 3500K 4000K Ra +84	120°	Remote Driver

IP20

UL US
Class 2

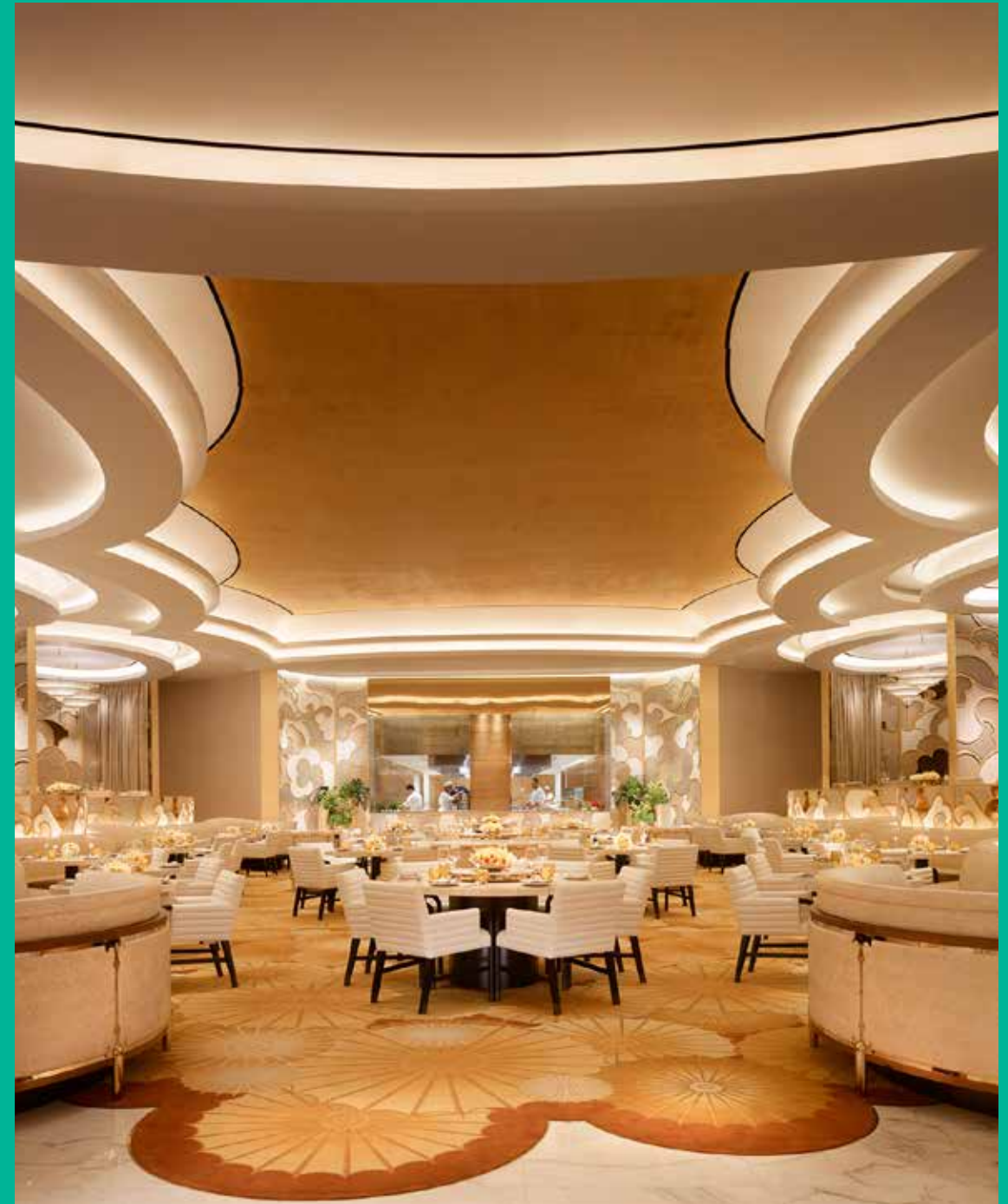

Wynn Palace Resort Hotel
Photos: © Roger Davis, Barbara Kraft

Targetti USA

750-A W. 17th St.
Costa Mesa, CA 92627

Phone. (714) 513-1991
targettiusa@targetti.com
www.targetti.us

Graphic design
Lcd Firenze

Print
Cappelli Arti Grafiche S.r.l

Targetti USA © 2020