



a brand of TARGETTI

DURATAPE™ RGB

IP20 INDOOR

KEY FEATURES

- High output saturated sharp RGB tones working together to create dynamic color changing effects.
- Ideal for IP20 interior applications such as cove, niche, architectural decorative application, lighting accents, custom and OEM product designs/chandliers.
- Sold per foot and manufactured to specified lengths with factory attached end preps.
- Features 2-circuit substrate for optimum heat dissipation, minimizing voltage drop while increasing run lengths per power feed, standardizing electrical flow over entire length of the strip for maximum product reliability.
- Features double sided solder points for maximum conductivity and durability.
- Pre-assembled to specific lengths with various connector options for project requirements and efficient power configuration.
- Max continuous length: up to 16' per run
- Multiple DMX512 drivers options available.

DIMENSIONAL DRAWINGS

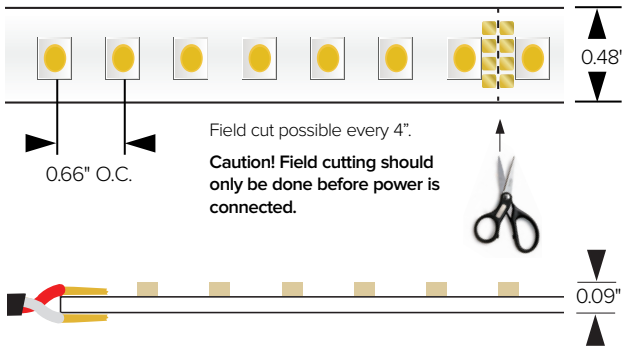

Duratape features double-sided solder points for maximum continuity for long lifespan.

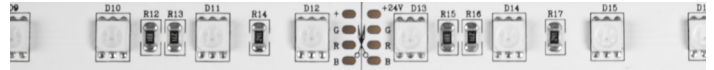

DETAILS

Spacing	0.66" OC LED Spacing
LEDs	18 LEDs per foot
Wattage	3.5W/ft
Color Temp	Tri Chip: Red 625nm / Green 520nm / Blue 450nm
Color Consistency	Bin centered on the Planck curve with a 2 step MacAdam tolerance.
End Preps	Factory prepped end preps available (See Page 2)
Mounting	Includes installation-ready 3M tape adhesive for simplified installation directly to mounting channel or application surface
Installation	Optional aluminum channels with base and cover can be used to install decorative, protective covers
Power Supply Listing	Listed Class 2 output, 24V DC power supply required cULus Class 2 Listed E471161 Tested in accordance with LM-79-08 Energy efficient for California installations.
Compliance Warranty	ROHS compliant 5 year warranty

FIXTURE DATA

Model	Efficacy Lm/Ft Lm/Wt	Wt/Ft
RGB*	46.86 164	3.5

* Meets Title 24 High efficacy rating.

LED DATA

Model	Wt/LED	Viewing Angle	Lifespan at 90% drive
RGB	0.20	120°	40,000hrs

* LEDs operating at 90% of LED manufacturers maximum current rating.

DESIGN INSTALLATION EXAMPLES



PRODUCT CODE	INTENSITY	WATTAGE	IP RATING	LED COLOR	VOLTAGE	+	END PREP	+	MOUNTING	+	POWER SUPPLY
DL — Duratape™	HO — High Output	35 — 3.5 W/ft	I — Indoor IP20	RGB — Red: 625nm, Green: 520nm Blue: 450nm	24 — 24 VDC						

END PREPS AND CONNECTORS (REQUIRED) - Choose 1

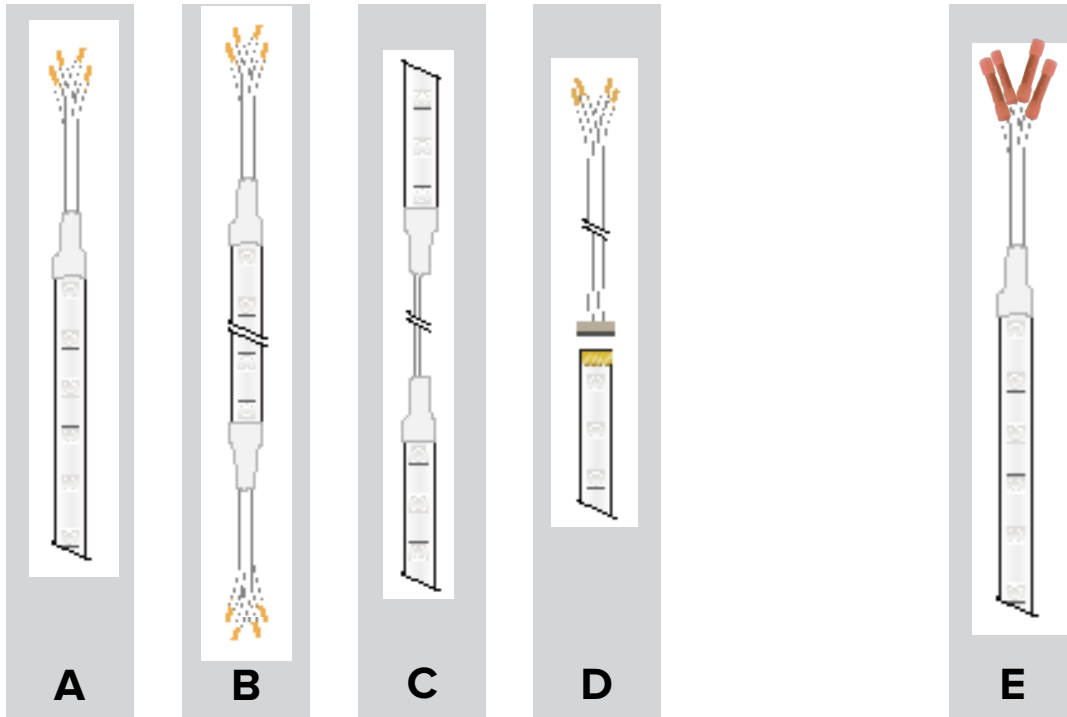

REQUIRED END PREPS:

(One required for each run of tape)

A

07UI3CBL1 (3-circuit RGB)

Factory attached single 3 circuit lead wire prep. 24" four conductor Lead wire/dead end allows for connection to power at lead end and field trim of Duratape product at the other end.

07UI3ADDCBL: ADDITIONAL LEAD WIRE

(3-circuit RGB)

Additional lead wire purchased per foot and factory attached to specified run leads. Lead wire can be field cut to desired length.

B

07UI3CBL2 (3-circuit RGB)

Factory attached double ended 3 circuit lead wire prep. 24" four conductor lead wire at both ends. One end can be used for power connectivity while the other end can be used for interconnection to run to an additional length of Duratape.

07UI3ADDCBL: ADDITIONAL LEAD WIRE

(3-circuit RGB)

Factory attached single 3 circuit lead wire prep. 24" four conductor Lead wire/dead end allows for connection to power at lead end and field trim of Duratape product at the other end.

C

07UI3FOLD CBL-XX (3-circuit RGB)

Factory attached 3 circuit wire fold (specified length). Wire folds are factory attached to Duratape to meet your specified installation requirements. Wire fold lengths available are 2", 3", 4", 6", 12". Add length number to end of part number.

D

07UI3LICON (3-circuit RGB)

Removable/lockable 3 circuit interconnect lead wire. 24" four conductor lead wire with locking and unlocking lead connector.

OPTIONAL CONNECTORS:

E

07UI3ADDCON (3-circuit RGB)

Additional 3 circuit connectors. Lead wire connectors 3/ea per connection.

PROFILE OPACITY LEVEL KEY:



Uniform
Direct View



Blended
Direct / Indirect View



Pixelated
Indirect View

SURFACE PROFILES

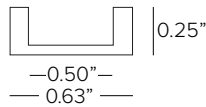
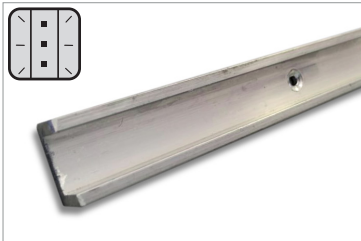

DL-ALUM-U-8

Low profile aluminum U-Profile for linear run lengths. Available in 8ft lengths.

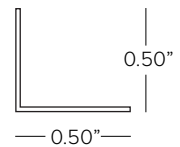

DL-ALUM-L-8

Aluminum L-Profile 1/2" x 1/2" for linear run lengths. Duratape can be mounted at either 0° or 90° mounting positions. Available in 8ft lengths.

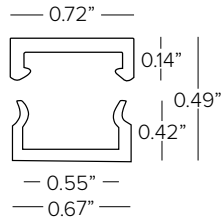

DL-W-2PC-C (Clear)

DL-W-2PC-F10/F30/F60 (Frosted)

Two-piece mounting tube; base (clear) with cover (frosted) for linear applications. Frosted diffusion levels, 10%, 30% or 60%. Available in 4' lengths.

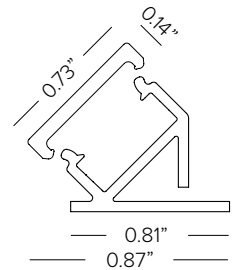
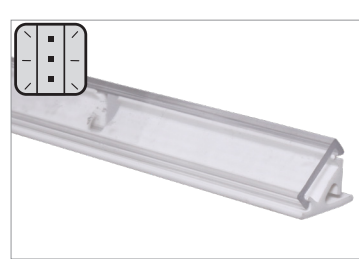

DL-C-45-MCH-4 (Base, REQUIRED)

45° mounting base (white) for 45° mounted linear applications. Available in 4' lengths.

DL-C-45-CVR-4-C (Cover, Clear)

DL-C-45-CVR-4-F10/F30/F60 (Cover, Frosted)

45° mounting base cover. Available in 4' lengths.

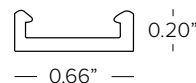

DL-MCHAN-8

Linear Mounting profile. Available in 8' lengths.

SURFACE PROFILES



P01B-S-PF-300

Aluminum profile with white PMMA screen for surface or recessed installation with limited width. Equipped with angle-joint accessory. Available in 118in (3M) lengths.

NOTE: 118 inch lengths must be shipped via freight only. For efficient shipping via UPS/Fedex, lengths can be cut to 59 inch upon request.



P01B-A-EC

3+3 pc silver end caps.

P01B-A-MC

4 Metal mounting clips.

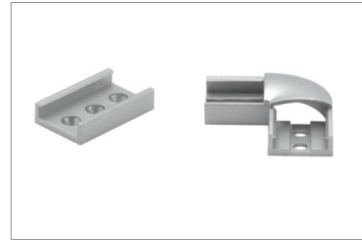
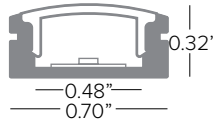

P01B-A-CP

3 pc silver color junction brackets.

P01B-A-CP90

3 pc silver color 90° junction brackets.

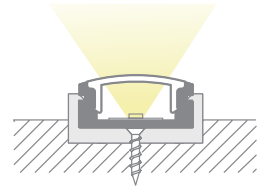
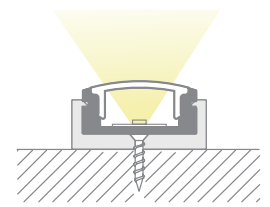

P02B-S-PF-300

Aluminum profile with white PMMA screen for surface or recessed installation with limited width. Equipped with angle-joint accessory. Available in 118in (3M) lengths.



P02B-A-EC

3+3 pc silver end caps.

P02B-A-MC

4 Metal mounting clips.

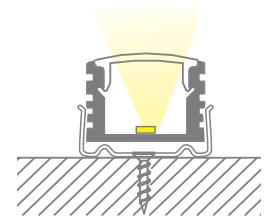
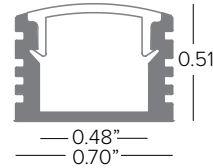

NOTE: 118 inch lengths must be shipped via freight only. For efficient shipping via UPS/Fedex, lengths can be cut to 59 inch upon request.



P03B-S-PF-300

Aluminum profile with polycarbonate lens with uniform light distribution for surface or recessed with suitable clips. Available in 118in (3M) lengths.



P03B-A-EC

3+3 pc silver end caps.

P03B-A-MC

3 Metal mounting clips.

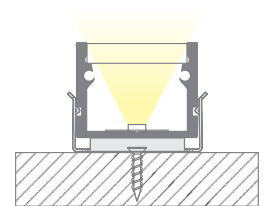
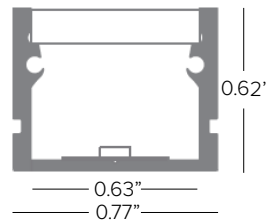

NOTE: 118 inch lengths must be shipped via freight only. For efficient shipping via UPS/Fedex, lengths can be cut to 59 inch upon request.

SURFACE PROFILES CONT.



P04B-S-PF-300

Aluminum profile with polycarbonate screen for surface or recessed with suitable clips. Available in 118in (3M) lengths.

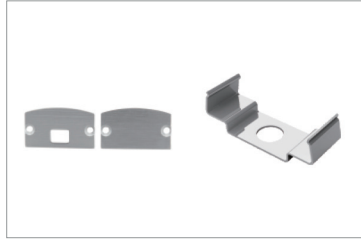

P04B-A-EC

3+3 pc metal end caps.

P04B-A-MC

3 Metal mounting clips.

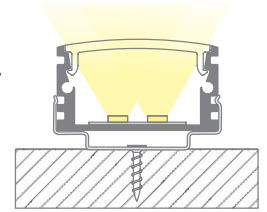
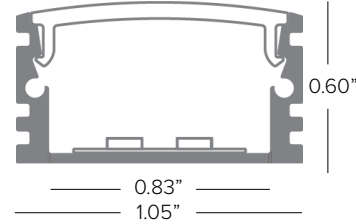

NOTE: 118 inch lengths must be shipped via freight only. For efficient shipping via UPS/Fedex, lengths can be cut to 59 inch upon request.

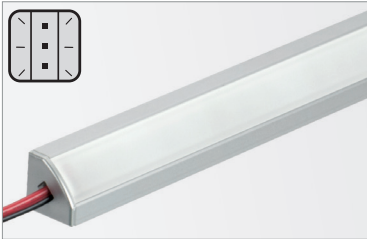

P03F-S-PF-300

Aluminum profile for surface or recessed corner with suitable clips. Available in 118in (3M) lengths.

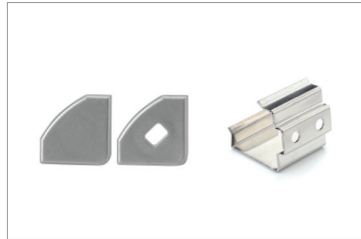

P03F-A-EC

3+3 pc end caps.

P03F-A-MC

3 Metal mounting clips.

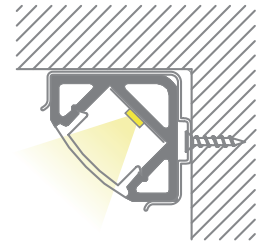
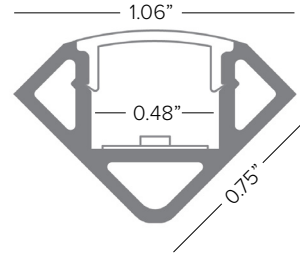

NOTE: 118 inch lengths must be shipped via freight only. For efficient shipping via UPS/Fedex, lengths can be cut to 59 inch upon request.



P04F-S-PF-300

Aluminum profile for surface in 90° angles with suitable clips. Available in 118in (3M) lengths.

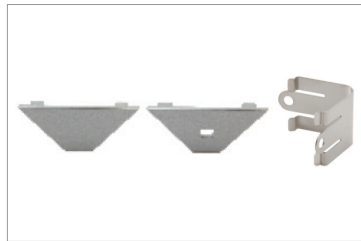

P04F-A-EC

3+3 pc end caps.

P04F-A-MC

3 Metal mounting clips.

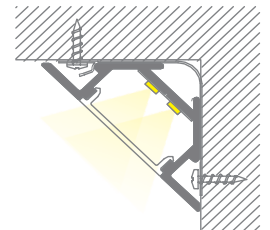
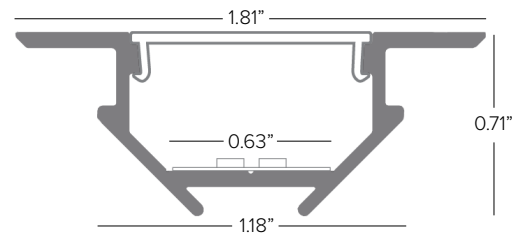

NOTE: 118 inch lengths must be shipped via freight only. For efficient shipping via UPS/Fedex, lengths can be cut to 59 inch upon request.

SURFACE PROFILES CONT.



PRAP-U

Surface mount aluminum profile. Anodized aluminum rigid profile complete with opal translucent diffuser cover. Available in 79in (2M) lengths.

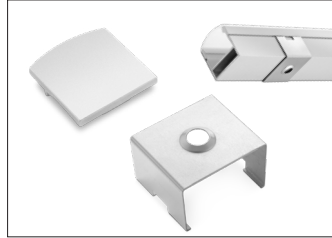

KTPRAP-UEC

5 + 5 silver color end caps

KTPRU-CL

5 sets of clips



OR-DEV

Set of steel supports required with use of KTORDEV-U.

KTORDEV-U

Set of aluminum mounting heads required with use of OR-DEV.

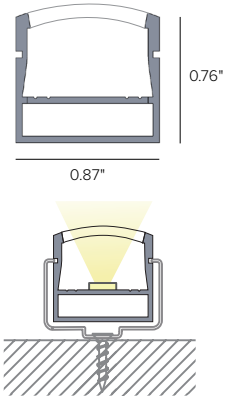

PRIN-U

Flush mount aluminum profile. Anodized aluminum rigid profile complete with opal translucent diffuser cover. Available in 79in (2M) lengths.

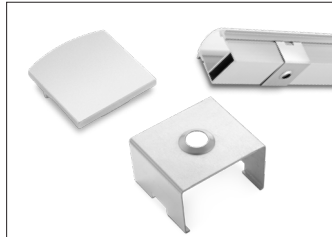

KTPRIN-UEC

5 + 5 silver color end caps

KTPRU-CL

5 sets of clips

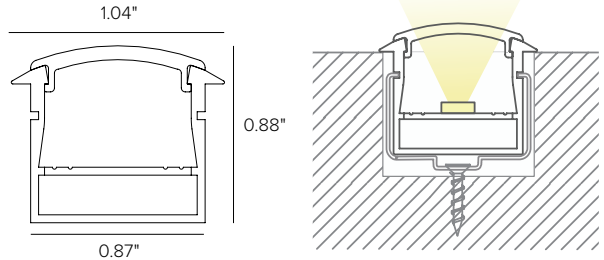

PRAN-U

45° aluminum profile. Anodized aluminum rigid profile complete with opal translucent diffuser cover. Available in 79in (2M) lengths.



KTPRAN-UEC

5 + 5 silver color end caps

KTPRAN-UCL

5 sets of clips

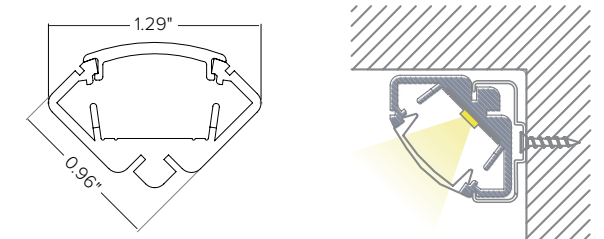

SURFACE PROFILES CONT.

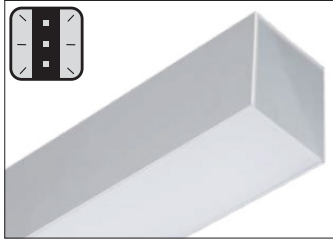

PRDESO
Aluminum profile for surface mount.
Available in 4ft lengths.

PRDESO-SL
Rear support for surface mount.

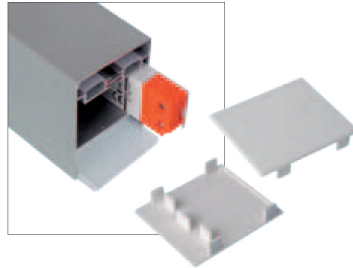

PRDESO-FL
Front screen in flat opal polycarbonate plate.

KTRDESO-FL
Set of two side end caps flat screen.

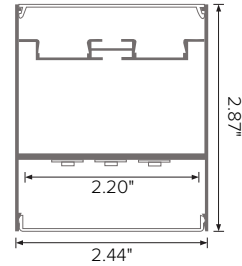

ADJUSTABLE PROFILES



P02C-S-PF-300
180° adjustable aluminum profile with wall washer function for surface with suitable clips. Available in 118in (3M) lengths.



P02C-A-EC
3+3 metal end caps.

P02C-A-OB
3 Metal adjustable brackets.

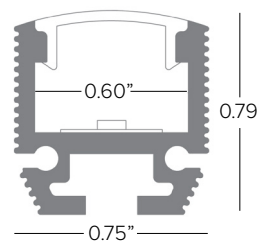

NOTE: 118 inch lengths must be shipped via freight only. For efficient shipping via UPS/Fedex, lengths can be cut to 59 inch upon request.

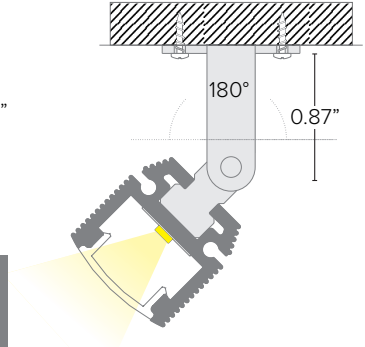

ADJUSTABLE PROFILES CONT.



P03C-S-PF-300

180° adjustable aluminum profile with wall washer function for surface with suitable clips. Lens shape creates narrower spread. Available in 118in (3M) lengths.

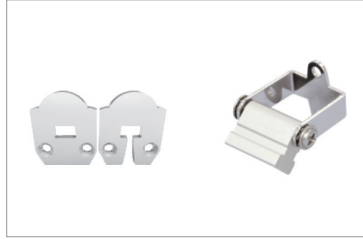

P03C-A-EC

3+3 metal end caps.

P03C-A-OB

6 Metal adjustable brackets.

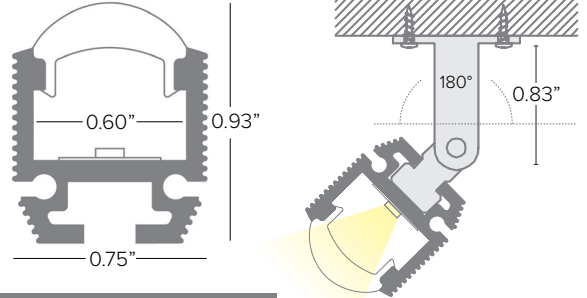

NOTE: 118 inch lengths must be shipped via freight only. For efficient shipping via UPS/Fedex, lengths can be cut to 59 inch upon request.



P04C-S-PF-300

Fixed profile at 30° with a wall washer function for surface installation. Available in 118in (3M) lengths.



P04C-A-EC

3+3 metal end caps.

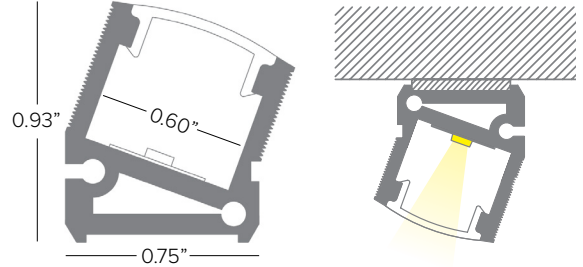

NOTE: 118 inch lengths must be shipped via freight only. For efficient shipping via UPS/Fedex, lengths can be cut to 59 inch upon request.

RECESSED PROFILES



P02H-S-PF-300

Aluminum profile with white PMMA screen for recessed installation with limited width. Available in 118in (3M) lengths.

NOTE: 118 inch lengths must be shipped via freight only. For efficient shipping via UPS/Fedex, lengths can be cut to 59 inch upon request.

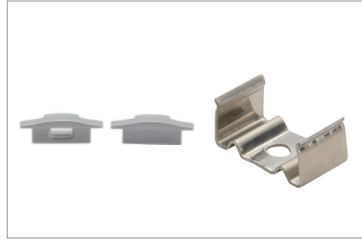

P02H-A-EC

3+3 pc silver end caps.

P02H-A-MC

3 Metal mounting clips.



P02H-A-CP

3 pc silver junction brackets.

P02H-A-CP90

3 junction brackets with 90° angle.

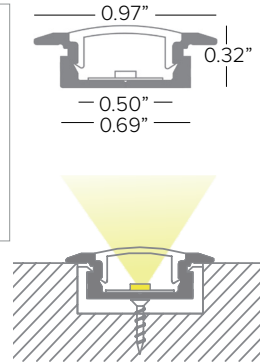

P03E-S-PF-300

Aluminum high impact walk over rated profile with white PMMA screen for recessed installation. Available in 118in (3M) lengths.

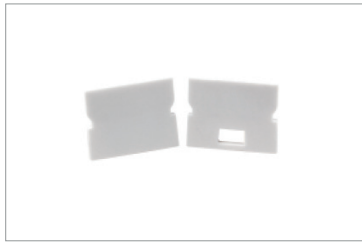

P03E-A-EC

3+3 pc end caps.

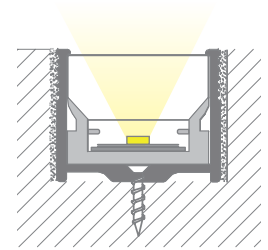
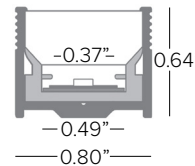

NOTE: 118 inch lengths must be shipped via freight only. For efficient shipping via UPS/Fedex, lengths can be cut to 59 inch upon request.



PRINTC-G

Rigid high impact resistant PMMA profile complete with a white plastic diffuser lensed channel for recessed walk over installation. Complete with track for easy strip insertion. Available in 3.28ft (1M) lengths.



KTRPRINTC-G

2+2 PC end caps

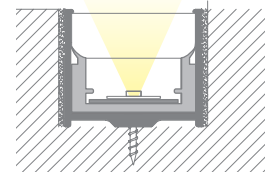
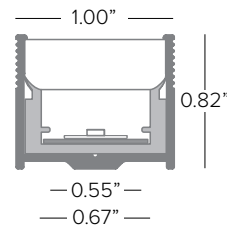

RECESSED PROFILES CONT.



PRINTC-GUS

Rigid high impact resistant PMMA profile complete with two part white plastic diffuser lens and aluminum channel for surface or recessed mounting. Available in 3.28ft (1M) lengths.



KTPRINTC-G

2+2 PC end caps

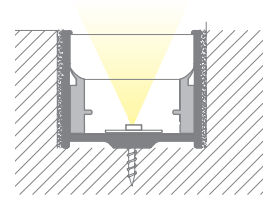
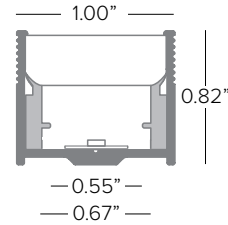

P04H-S-PF-300

Aluminum profile with white polycarbonate screen for recessed installation. Available in 118in (3M) lengths.

NOTE: 118 inch lengths must be shipped via freight only. For efficient shipping via UPS/Fedex, lengths can be cut to 59 inch upon request.



P04H-A-EC

3+3 pc silver end caps.

P04H-A-MC

3 Metal mounting clips.



P04H-A-FS

3 pc metal ceiling attachment springs.

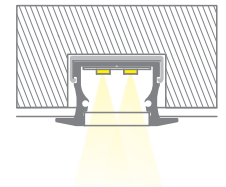
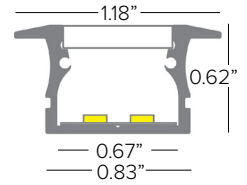
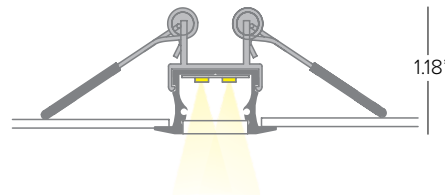

P08D-S-PF-300

Aluminum profile with white PMMA screen for recessed installation. Available in 118in (3M) lengths.

Max of (2) strips per profile.

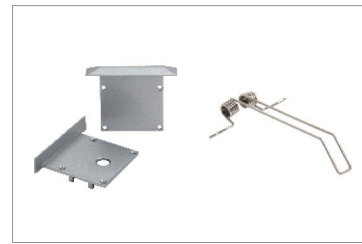

P08D-A-EC

3+3 pc silver end caps.

P08D-A-SP

3 pc metal ceiling attachment springs.

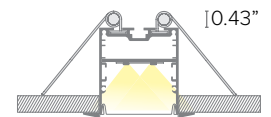
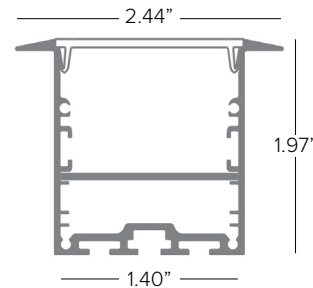

NOTE: 118 inch lengths must be shipped via freight only. For efficient shipping via UPS/Fedex, lengths can be cut to 59 inch upon request.

SUSPENSION PROFILES

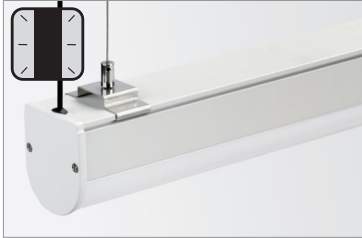

P07A-S-PF-300

Aluminum profile with white polycarbonate screen for surface or suspension installation. Available in 118in (3M) lengths.

NOTE: 118 inch lengths must be shipped via freight only. For efficient shipping via UPS/Fedex, lengths can be cut to 59 inch upon request.

Max of (3) strips per profile.

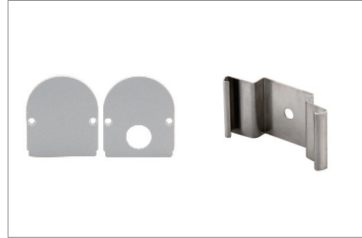

P07A-A-EC

3+3 pc white end caps.

P07A-A-MC

6 Metal mounting clips.
(One set recommended for every 4ft)



P07A-A-FS

3 pc metal suspension cables.

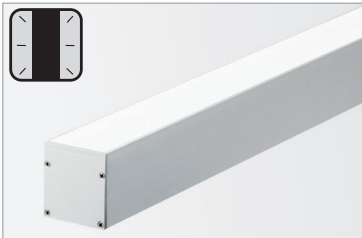
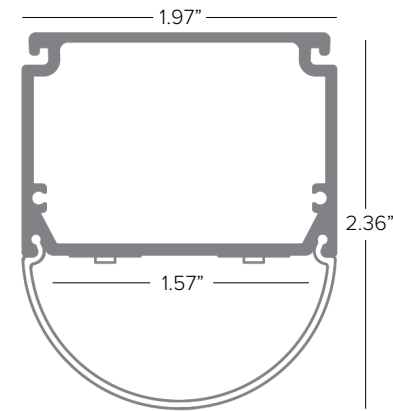
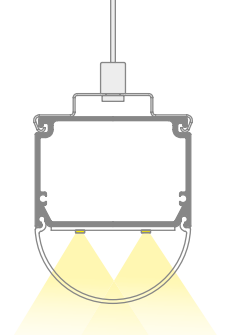

P01L-S-PF-300

Aluminum profile with white polycarbonate screen for suspension installation. Available in 118in (3M) lengths.

NOTE: 118 inch lengths must be shipped via freight only. For efficient shipping via UPS/Fedex, lengths can be cut to 59 inch upon request.

Max of (3) strips per profile.



P01L-A-EC

3+3 pc silver end caps.



P01L-A-FS

3 pc metal suspension cables.

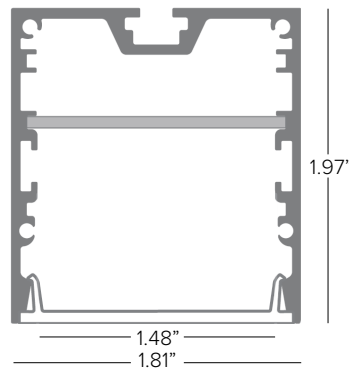
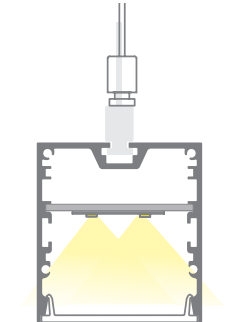

DECORATIVE PROFILES



P06A-S-PF-300

Aluminum profile with white PMMA screens for wall installation with wall washer effect upwards and downwards. Available in 118in (3M) lengths.

Max of (1) strip per profile direction.

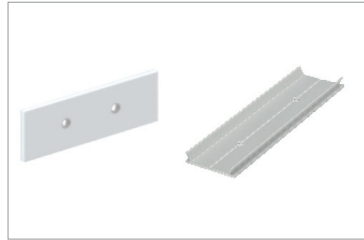

P06A-A-EC

3+3 pc silver end caps.

P06A-A-MC

1 set of metal brackets.

NOTE: 118 inch lengths must be shipped via freight only. For efficient shipping via UPS/Fedex, lengths can be cut to 59 inch upon request.

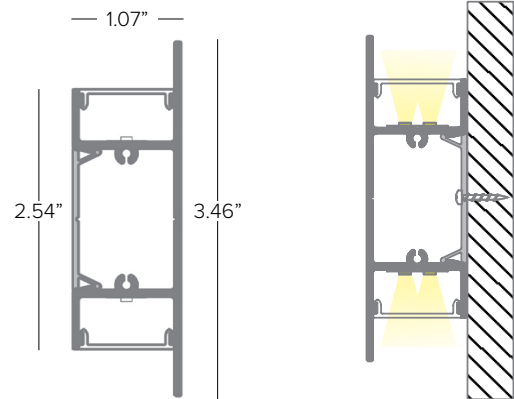

Power Supply (REQUIRED)	Type	Wattage	Input/Output Voltage	Dimmable	IP Rating	Output	Dimensions
DEDD1001243CDMX	ELECTRONIC ADDRESSABLE DMX DRIVER	100W	120-277V / 24V	DMX CONTROL 3 CHANNEL	NEMA1 ENCLOSURE	UL CLASS 2	12" x 12" x 4"
DEDD2002243CDMX	ELECTRONIC ADDRESSABLE DMX DRIVER	2X100W	120-277V / 24V	DMX CONTROL 3 CHANNEL	NEMA1 ENCLOSURE	UL CLASS 2	12" x 12" x 4"

¹ Dimensions include enclosure with mounting bracket.

* Constant voltage drivers 50/60HZ, voltage regulated with short circuit protection. Operating temperature -40 C- 80° C

* Installation of power supply must be compliant to Class 2 installation standards. Refer to NEC and local building code requirements.

MAXIMUM INTERCONNECTED TAPE LENGTH PER DRIVER

Fixture Wattage	Driver Wattage								
	40W	60W	96W	90W	2X90W	3X90W	100W	2X100	
3.5W/ft	9FT	13FT	21FT	20FT	(2) 20FT	(3) 20FT	22FT	(2) 22FT	

Controllers:

Part No.	Type	Application	Voltage	Listing	Dimensions	Channels	Zones	Scenes
SWITCH20	RGBW touch DMX512 wall control keypad with sensitive glass touch panel, white finish.	Indoor	12-24V DC	UL	4.7" x 3.0" x 1.2"	12	3	1
TGDMXSLESAU9	Stand-alone DMX 1/2 Universe Programmable Controller with Easy to Use Software Interface	Indoor Only	5.5V DC	ETL, UL	5.3"W x 5.5"H x 1.9D	256	1	20
TGDMXSLESAU11	Nicolaudie Slesla smart DMX interface, 2 DMX 512 universes, intuitive backlit keyboard programmable controller with easy to use software interface.	Indoor	5VDC 120V AC (Plug in power supply included)	ETL	6.3" x 3.6" x 1.8"	1024	5	99
TGDMXSTICKDE3B	Nicolaudie intelligent wall control keypad with glass touch sensitive graphic display, stand-alone DMX 512, 2 universe programmable controller with easy to use software interface. Black finish.	Indoor	6-7V DC 120V AC (Plug in power supply included)	ETL	5.8" x 4.2" x 0.5"	1024	10	500
TGDMXSTICKDE3W	Nicolaudie intelligent control keypad with glass touch sensitive graphic display, stand-alone DMX 512, 2 universe programmable controller with easy to use software interface. White finish.	Indoor	6-7V DC 120V AC (Plug in power supply included)	ETL	5.8" x 4.2" x 0.5"	1024	10	500



SWITCH20



TGDMXSLESAU9



TGDMXSLESAU11

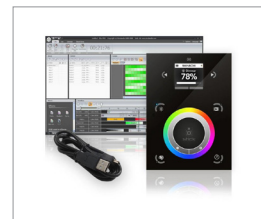

TGDMXSTICKDE3