

# EUROSTANDARD PLUS TRACK - SURFACE/SUSPENSION

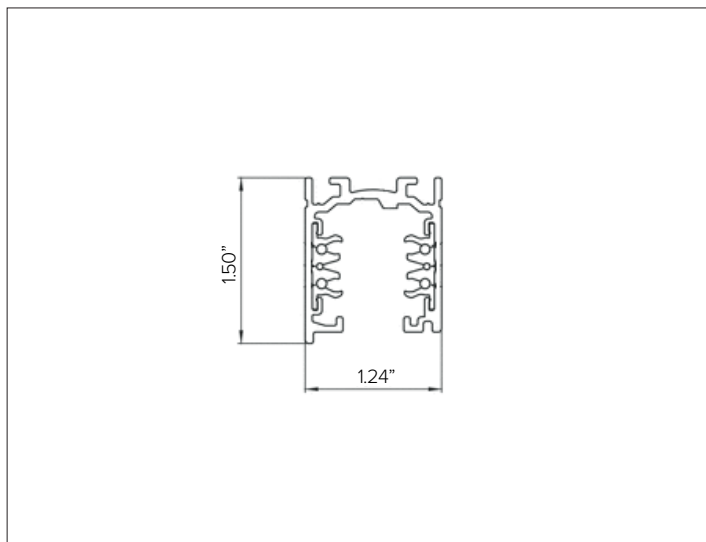

## CONCEPT

Surface/suspension mounted electrified track system.

## MECHANICAL CHARACTERISTICS

**Dimensions** 1.24"W X 1.50"H

**Materials** Aluminum track with copper conductors that feed electricity to the fixture and provide attachment support.

**Finish**  White  Black

**Power Connection** Mechanical electrical polarized connections. For current limiting solutions, integral current limiter breaker option or 3rd party current limiter breaker panel to be supplied by others.

**Functionality** Different mounting configurations are achievable using electrical feeds and connectors that make it possible to build a simple or complex systems.

**Mounting** To be installed in surface or suspension configurations that is achieved through different available mounting options.

**Weight** 0.5lbs/ft

**Protection** IP20

## ELECTRICAL CHARACTERISTICS

**Voltage** 120V/60Hz

**Circuit** 3-circuit, 4+2 conductor

**Frequency** 60Hz

**Control** 0-10V Dimming

## CERTIFICATIONS

cULus Listed.  
RoHS3 EU 215/863

## WARRANTY

5 year limited warranty.

# EUROSTANDARD PLUS TRACK - SURFACE/SUSPENSION

## SPECIFICATION INFORMATION



Ex: 9000-UL4/W-ST-120 / 9004/W / S-9000/T / 9001/W-3C / S-9000/131-W

1 - TRACK	2 - END CAP	3 - DECORATIVE COVER	4 - CUTTING TOOL	5 - ELECTRICAL FEED	6 - ELECTRICAL CONNECTOR	7 - MOUNTING
<b>REQUIRED</b>	<b>REQUIRED</b>	<b>OPTIONAL</b>	<b>REQUIRED</b>	<b>REQUIRED</b>	<b>OPTIONAL</b>	<b>REQUIRED</b>

### 1 - TRACK (REQUIRED)

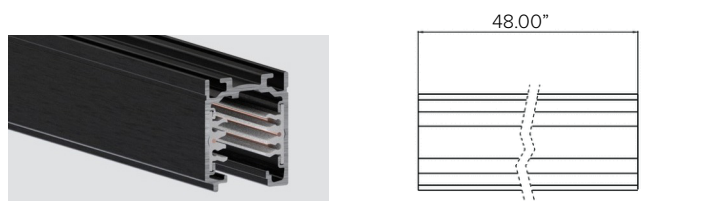

STUCCHI EUROSTANDARD PLUS surface mounting track, field cuttable with specialized tool (REQUIRED).

Finish  White  Black

Part No. **9000-UL4/W-ST-120** **9000-UL4/B-ST-120**

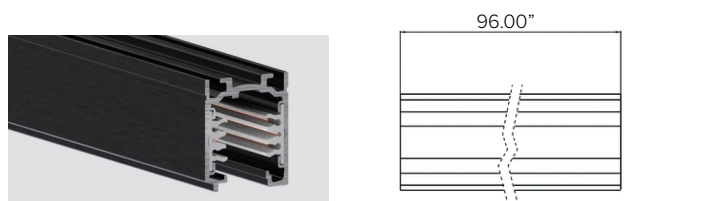

STUCCHI EUROSTANDARD PLUS surface mounting track, field cuttable with specialized tool (REQUIRED).

Finish  White  Black

Part No. **9000-UL8/W-ST-120** **9000-UL8/B-ST-120**

### 2 - END CAP (REQUIRED)

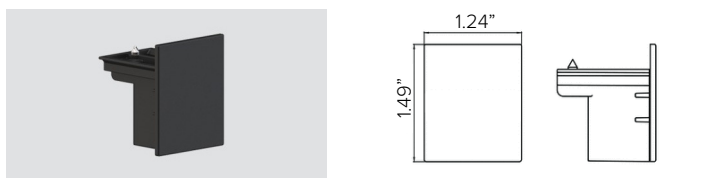

STUCCHI EUROSTANDARD PLUS surface mounting track end cap kit, 5pcs.

Finish  White  Black

Part No. **9004/W** **9004/B**

### 3 - DECORATIVE COVER (OPTIONAL)

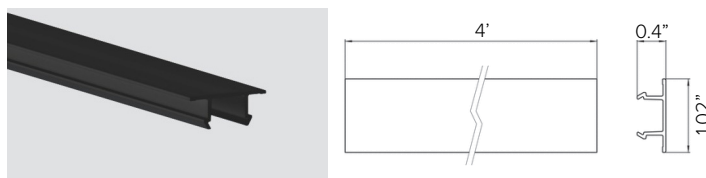

STUCCHI EUROSTANDARD PLUS decorative track cover strip, 10pcs.

Finish  White  Black

Part No. **S-9000/GP-W-UL4** **S-9000/GP-B-UL4**

### 4 - CUTTING TOOL (REQUIRED)



Cutting tool for track conductors.

**S-9000/T**

# EUROSTANDARD PLUS TRACK - SURFACE/SUSPENSION

## 5 - ELECTRICAL FEED (REQUIRED)

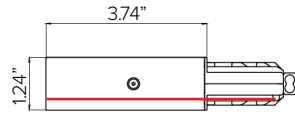

STUCCHI EUROSTANDARD PLUS end feed polarity right/ground left.

Finish  White  Black

Part No. **9001/W-3C** **9001/B-3C**

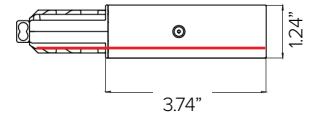

STUCCHI EUROSTANDARD PLUS end feed polarity left/ground right.

Finish  White  Black

Part No. **9002/W-3C** **9002/B-3C**

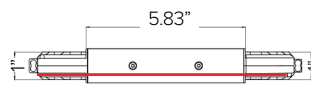
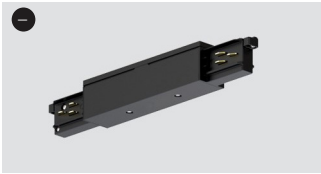

STUCCHI EUROSTANDARD PLUS linear middle feed with ground.

Finish  White  Black

Part No. **9010/W-3C** **9010/B-3C**

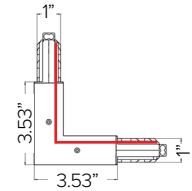
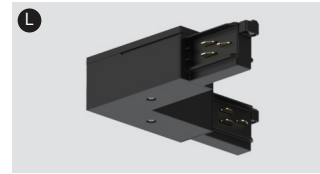

STUCCHI EUROSTANDARD PLUS L – Feed polarity internal/ground external.

Finish  White  Black

Part No. **9011/W-3C** **9011/B-3C**

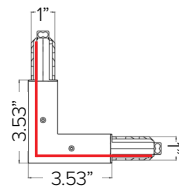

STUCCHI EUROSTANDARD PLUS L – Feed polarity external/ground internal.

Finish  White  Black

Part No. **9012/W-3C** **9012/B-3C**

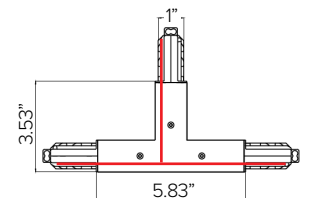
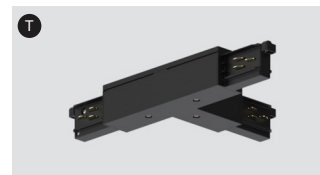

STUCCHI EUROSTANDARD PLUS T – Feed polarity external left/ground internal right.

Finish  White  Black

Part No. **9013/W-3C** **9013/B-3C**

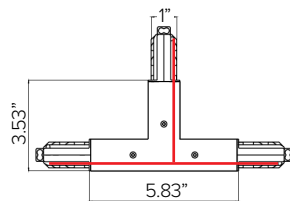

STUCCHI EUROSTANDARD PLUS T – Feed polarity external right/ground internal left.

Finish  White  Black

Part No. **9014/W-3C** **9014/B-3C**

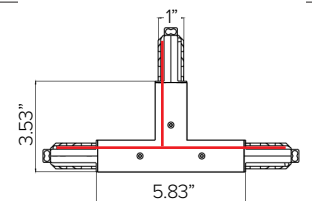

STUCCHI EUROSTANDARD PLUS T – Feed polarity internal left/ground external right.

Finish  White  Black

Part No. **9015/W-3C** **9015/B-3C**

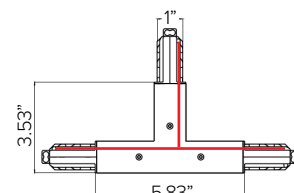
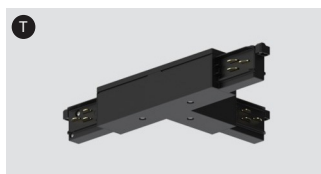

STUCCHI EUROSTANDARD PLUS T – Feed polarity internal right/ground external left.

Finish  White  Black

Part No. **9016/W-3C** **9016/B-3C**

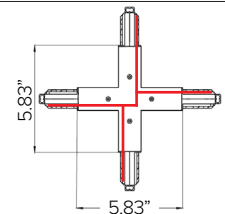

STUCCHI EUROSTANDARD PLUS X – Feed.

Finish  White  Black

Part No. **9017/W-3C** **9017/B-3C**

# EUROSTANDARD PLUS TRACK - SURFACE/SUSPENSION

## 5 - ELECTRICAL FEED CONT. (REQUIRED)

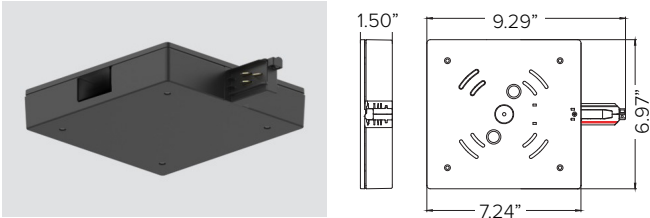

STUCCHI EUROSTANDARD PLUS end feed current limiter 3 + 1 circuit 120V/60Hz with 0-10V dimming and copper alloy contacts, polarity right/ground left. For surface mount applications only, mounts directly to 4" square or octagonal junction box.

**Carling single pole M-series circuit breaker with integrated on/off rocker switch to be provided by others accordingly to local building code requirements, 3ea per current limiter enclosure. To be used for California T24 applications limiting watts per foot to comply with energy regulations.**

Finish	<input type="radio"/> White	<input checked="" type="radio"/> Black
Part No.	<b>9001-CL/W-3C</b>	<b>9001-CL/B-3C</b>

## 6 - ELECTRICAL CONNECTOR (OPTIONAL)



STUCCHI EUROSTANDARD PLUS linear joint connector.

Finish	<input type="radio"/> White	<input checked="" type="radio"/> Black
Part No.	<b>9003/W</b>	<b>9003/B</b>

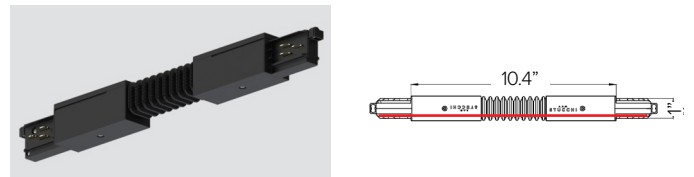

STUCCHI EUROSTANDARD PLUS adjustable corner connector.

Finish	<input type="radio"/> White	<input checked="" type="radio"/> Black
Part No.	<b>9018/W-3C</b>	<b>9018/B-3C</b>

# EUROSTANDARD PLUS TRACK - SURFACE/SUSPENSION

## 7 – MOUNTING (REQUIRED)



STUCCHI EUROSTANDARD PLUS suspension kit, bracket with automatic gripper. Round head ceiling attachment with steel cable (Ø 0.06in X 16ft L), spherical end and short pendant bracket with countersink hole. Suggested 2pcs for 4ft L track, 3pcs for 8ft L track.

Finish  White  Black  
 Part No. **9000-KIT8-5-W** **9000-KIT8-5-B**



STUCCHI EUROSTANDARD PLUS suspension kit, bracket with automatic gripper. Screw gripper with finished plastic cup and steel cable (Ø 0.06in X 16ft L). Suggested 2pcs for 4ft L track, 3pcs for 8ft L track.

Finish  White  Black  
 Part No. **9000-KIT3-5-W** **9000-KIT3-5-B**

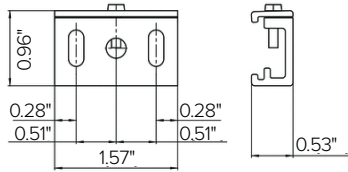

STUCCHI EUROSTANDARD PLUS track surface ceiling bracket. Suggested 2pcs for 4ft L track, 3pcs for 8ft L track.

Finish  White  Black  
 Part No. **S-9000/131-W** **S-9000/131-B**

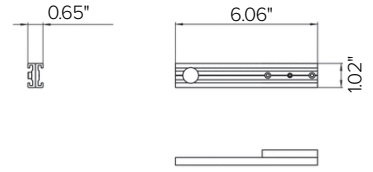

STUCCHI EUROSTANDARD PLUS reinforcing bracket for end feed. (OPTIONAL)

Finish  White  Black  
 Part No. **S-9001/SU-W** **S-9001/SU-B**

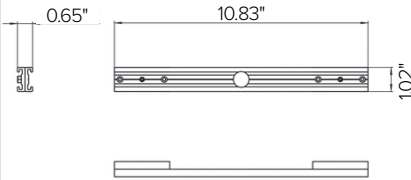
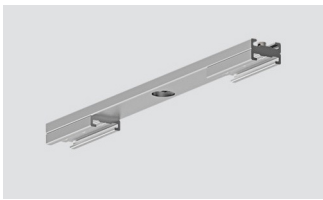

STUCCHI EUROSTANDARD PLUS reinforcing bracket for middle feed. (OPTIONAL)

Finish  White  Black  
 Part No. **S-9010/SU-W** **S-9010/SU-B**

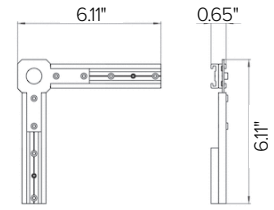
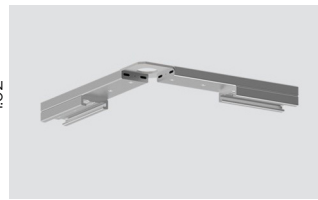

STUCCHI EUROSTANDARD PLUS reinforcing bracket for L-feed. (OPTIONAL)

Finish  White  Black  
 Part No. **S-9011/SU-W** **S-9011/SU-B**

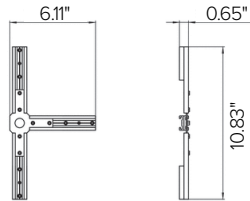
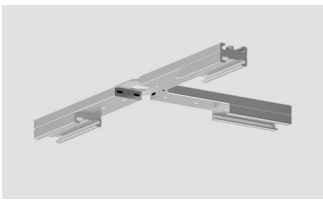

STUCCHI EUROSTANDARD PLUS reinforcing bracket for T-feed. (OPTIONAL)

Finish  White  Black  
 Part No. **S-9013/SU-W** **S-9013/SU-B**

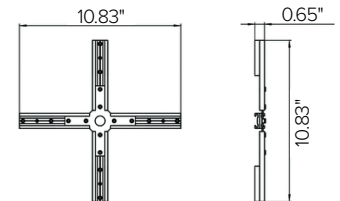
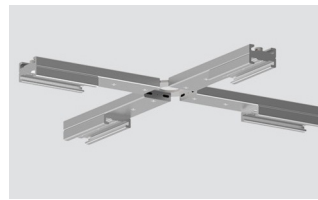

STUCCHI EUROSTANDARD PLUS reinforcing bracket for X-feed. (OPTIONAL)

Finish  White  Black  
 Part No. **S-9017/SU-W** **S-9017/SU-B**