

SATURN MINI

Miniature Direct View LED Marker Light

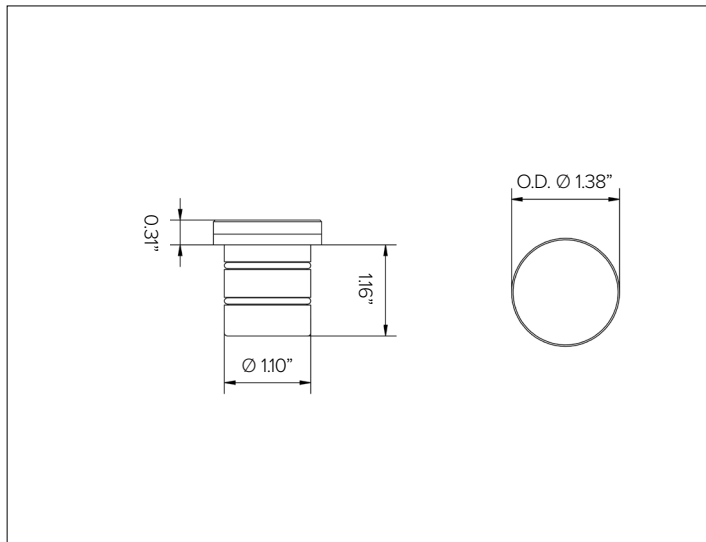

CONCEPT

Miniature direct view recessed ingrade / wall marker light.

FIXTURE MECHANICAL CHARACTERISTICS

Housing	Ø 1.38" Dia.
Materials	Milled anodized aluminum marine grade cataphoresis ^A body. Opal white .35" thick polymethyl methacrylate lens.
Power Connection	Pre-cabled with 2ft direct burial 18ga 2 conductor cable for connection to remote power supply.
Mounting	Recessed mounting with installation sleeve (required).
Installation	Flush recessed ingrade / wall mounting installation sleeve with adjustable collar for precision mounting, see available options.
Protection	IP67
Resistance	Walkover rated only.

CERTIFICATIONS

cULus Class 2 Wet Location Listed.
 Tested in accordance with LM-79-08.
 Compliant for California installations.
 Made in America, BAA, BABA

WARRANTY

5 year limited warranty.
^A Fixture body complete with marine grade suitable for use in marine grade environments. Not to be in direct contact with salt or corrosive agents for extended periods of time.

SUSTAINABILITY

Luminaire designed for disposal/recycling at end-of-life. Replaceable LED light source and control gear by a Targetti technician.

ELECTRICAL CHARACTERISTICS

Driver	Remote Class 2 120V-277V AC power supply required, see available options.
Wattage	3W nominal
Voltage	24V DC
Operating Temp.	-25°C / +35°C

SOURCE

High Efficiency LED

TM30	CCT (Nominal)	CRI	Rf	Rg	SDCM
	2200K	97	94	103	2
	2700K	98	95	102	2
	3000K	98	95	102	2
	3500K	97	90	98	2
	4000K	96	90	98	2

OPTIC

Direct view opal white lens.

Beam	 DV	
Delivered Lumens	3000K	11Lm
	4000K	12Lm
	<i>For 2700K lumen values use multiplier of 0.96 from 3000K. For 3500K lumen values use multiplier of 1.02 from 3000K.</i>	
Efficacy	4Lm/W max. Refer to photometric graphs for specific values.	
Lifetime	L70/B10 >35,000hrs at max TA +25°C	
Photobiological Classification	Low risk safety RG1	

SATURN MINI

SPECIFICATION INFORMATION



Ex: SAMRPDVL13024 / DMLE301242UD / 1US3178S

1 - PRODUCT CODE	3 - DRIVER	4 - LENS	5 - WATTAGE	6 - KELVIN	7 - VOLTAGE
SAM — SATURN MINI	RP — Remote Driver	DV — Direct View	L1 — 3W	22 — 2200K 27 — 2700K 30 — 3000K 35 — 3500K 40 — 4000K	24 — 24V DC

8 - DRIVER	9 - INSTALLATION	10 - INSTALLATION ACCESSORIES
Power Supply See section for details	2" Installation Sleeve See section for details 3" Installation Sleeve See section for details 6" Installation Sleeve See section for details 9" Installation Sleeve See section for details	Sleeve mounting HUB See section for details Installation J-box See section for details

SATURN MINI

8 - POWER SUPPLY (REQUIRED)

ENCLOSURE								
Part No.	Wattage	Control	Dim Range	Rating	In / Out Voltage	Certification	Dimensions (Enclosure)	Description
DMLE301242UD	30W	MLV / ELV / 0-10V / TRIAC	MLV / ELV <10% 0-10V 1%	NEMA3R	120-277V / 24V	UL Class 2	4.47" X 6.79" X 1.38"	EMCOD electronic driver with wiring compartment.
DELV30124DJBX	30W	0-10V	0.1%	IP65	120-277V / 24V	UL Class 2	12.1" X 2.4" X 1.4"	Magnitude SOLIDrive electronic driver with built in junction box.
DMLE601242UD	60W	MLV / ELV / 0-10V / TRIAC	MLV / ELV <10% 0-10V 1%	NEMA3R	120-277V / 24V	UL Class 2	4.47" X 6.79" X 1.38"	EMCOD electronic driver with wiring compartment.
DELV60124DJBX	60W	0-10V	0.1%	IP65	120-277V / 24V	UL Class 2	12.1" X 2.4" X 1.4"	Magnitude SOLIDrive electronic driver with built in junction box.
DMLE961242UD	96W	MLV / ELV / 0-10V / TRIAC	MLV / ELV <10% 0-10V 1%	NEMA3R	120-277V / 24V	UL Class 2	5.16" X 7.73" X 1.54	EMCOD electronic driver with wiring compartment.
DELV96124DJBX	96W	0-10V	0.1%	IP65	120-277V / 24V	UL Class 2	12.1" X 2.4" X 1.4"	Magnitude SOLIDrive electronic driver with built in junction box.
DEDDX100241CDMX	100W	DMX 1Ch Group Control	0%	NEMA3R	120-277V / 24V	UR Class 2	12" x 12" x 4"	EldoLED LINEARdrive electronic driver.
DMLE1922242UD	2X96W	MLV / ELV / 0-10V / TRIAC	MLV / ELV <10% 0-10V 1%	NEMA3R	120-277V / 24V	UL Class 2	5.04" X 10.94" X 1.81	EMCOD electronic driver with wiring compartment.
DEDDX200241CDMX	2X100W	DMX 1Ch Group Control	0%	NEMA3R	120-277V / 24V	UL Class 2	12" x 12" x 4"	EldoLED LINEARdrive electronic driver.
DMLE2882242UD	3X96W	MLV / ELV / 0-10V / TRIAC	MLV / ELV <10% 0-10V 1%	NEMA3R	120-277V / 24V	UL Class 2	5.04" X 10.94" X 1.81	EMCOD electronic driver with wiring compartment.

STAND ALONE								
Part No.	Wattage	Control	Dim Range	Rating	In / Out Voltage	Certification	Dimensions (Standalone)	Description
DELV30124D	30W	0-10V	0.1%	IP65	120-277V / 24V	UR Class 2	7.5" X 2.4" X 1.4"	Magnitude SOLIDrive electronic standalone driver. UL listed enclosure provided by others.
DELV60124D	60W	0-10V	0.1%	IP65	120-277V / 24V	UR Class 2	7.5" X 2.4" X 1.4"	Magnitude SOLIDrive electronic standalone driver. UL listed enclosure provided by others.
DELV96124D	96W	0-10V	0.1%	IP65	120-277V / 24V	UR Class 2	7.5" X 2.4" X 1.4"	Magnitude SOLIDrive electronic standalone driver. UL listed enclosure provided by others.

MAX FIXTURES PER DRIVER										
Fixture Wattage	Driver Wattage									
	30W	60W	90W	96W	100W	2X90W	2X96W	2x100W	3X90W	3X96W
3W	8	16	24	25	26	24+24	25+25	26+26	24+24+24	25+25+25

SATURN MINI

9 – INSTALLATION (REQUIRED)

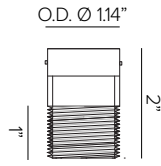

SATURN MINI 2" installation sleeve. Tube with threaded bottom end for height adjustment up to 3/4" for precision mounting.

Part No. **1US3178S**

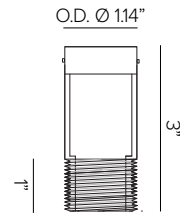

SATURN MINI 3" installation sleeve. Tube with threaded bottom end for height adjustment up to 3/4" for precision mounting. 2" field cut allowance.

Part No. **1US3178M**

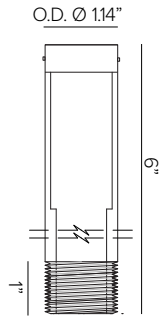

SATURN MINI 6" installation sleeve. Tube with threaded bottom end for height adjustment up to 3/4" for precision mounting. Can be used with inground paver installation. 2" field cut allowance.

Part No. **1US3178L**

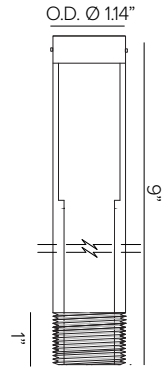

SATURN MINI 9" installation sleeve. Tube with threaded bottom end for height adjustment up to 3/4" for precision mounting. Can be used with inground paver installation. 2" field cut allowance.

Part No. **1US3178X**

10 – INSTALLATION ACCESSORIES (OPTIONAL)

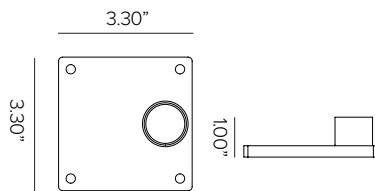

SATURN MINI HUB with 3/4" height adjustability for field leveling mounted on 3-3/4" square j-box cover. Optional for use of sleeve only.

Part No. **1US3178HB**

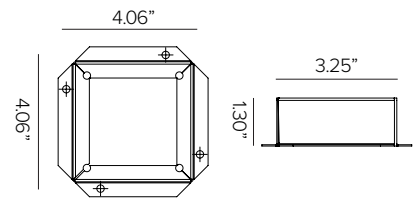

3-1/2" x 3-4/4" installation J-box. Aluminum with 2ea 1/2" and 2ea 3/4" knockouts. Optional for use with HUB only.

Part No. **1US3178X**

SATURN MINI

INSTALLATION DIAGRAMS

In-Ground Mounting

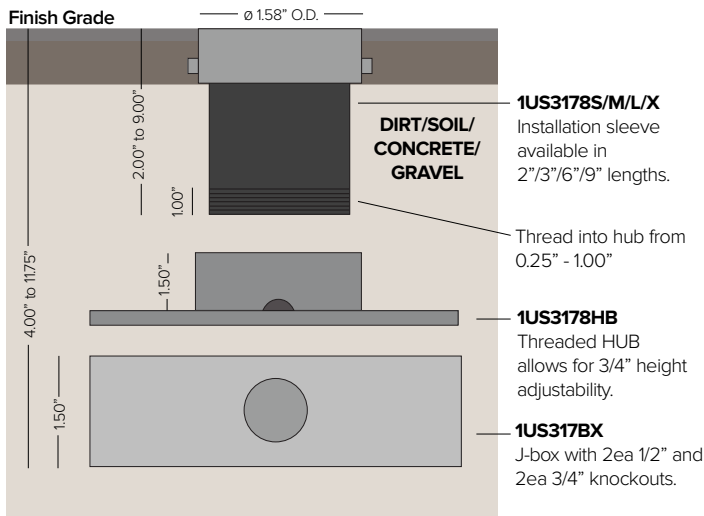

Flush Wall Mount

Recessed sleeve with collar for flush mounting.

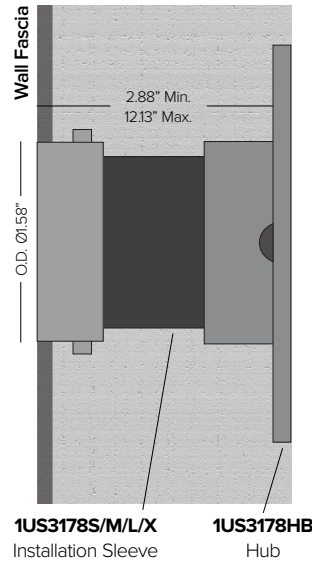

Surface Wall Mount

Recessed sleeve without collar for surface mount with outer glow effect.

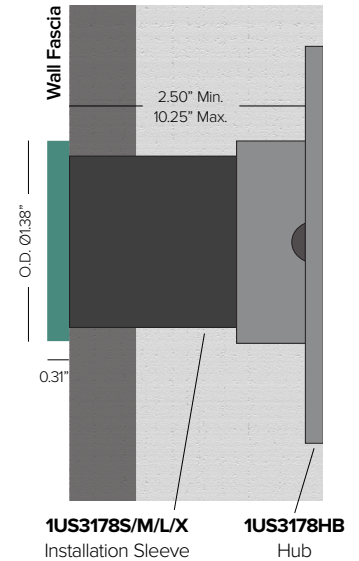

Overall Heights

- 2" Installation Sleeve = 4.00" Min to 4.75" Max
- 3" Installation Sleeve = 5.00" Min to 5.75" Max
- 6" Installation Sleeve = 8.00" Min to 8.75" Max
- 9" Installation Sleeve = 11.00" Min to 11.75" Max

WIRING DIAGRAM

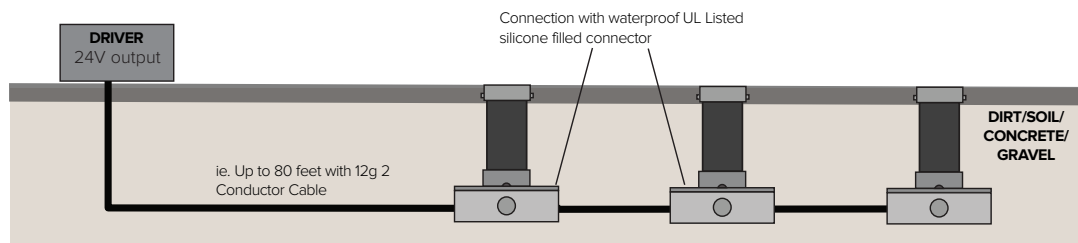

NOTE: Low voltage outdoor landscape wiring to be installed by a certified electrician per local building requirements, max 4A 96W circuit.

SATURN MINI

PHOTOMETRY



		3000K	H(m)	D(m)	Emax(lx)	
		Ra84		122°		
Fixture Power	3W	1	3.59	4		
Source Flux	353lm	2	7.18	1		
Fixture Flux	11lm	3	10.77	0		
Efficacy	4lm/W	4	14.36	0		
TS1052	Imax=10cd/klm	Imax	4cd	5	17.95	0



		4000K	H(m)	D(m)	Emax(lx)	
		Ra84		122°		
Fixture Power	3W	1	3.59	4		
Source Flux	378lm	2	7.18	1		
Fixture Flux	12lm	3	10.77	0		
Efficacy	4lm/W	4	14.36	0		
TS1052	Imax=10cd/klm	Imax	4cd	5	17.95	0