

# OZ 48V LARGE SURFACE/SUSPENSION PROFILE

## Magnet Mounted Modular Light System

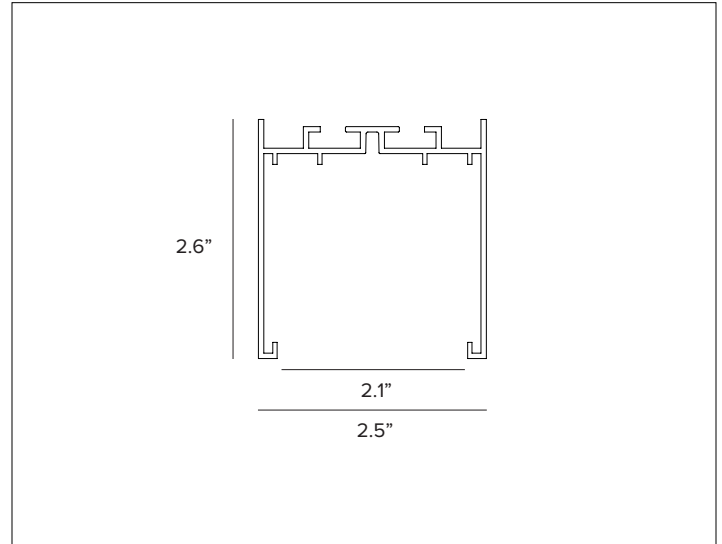

### CONCEPT

Professional magnet mounted low voltage modular light system allowing for maximum application flexibility.

### MECHANICAL CHARACTERISTICS

<b>Dimensions</b>	2.5"W x 2.6"H
<b>Materials</b>	Extruded painted aluminum profile.
<b>Finish</b>	<input type="radio"/> Plaster White <input checked="" type="radio"/> Deep Black
<b>Functionality</b>	Different mounting configurations are achievable using joint connectors that make it possible to build a simple or complex systems. To be completed with OZ 48V Power Rail for electrical connections.
<b>Mounting</b>	Ceiling or suspension for Lead / Stand Alone or Center / End profiles. Profile system configurations are achieved through optional joint connectors.
<b>Weight</b>	3.33ft L: 2.5lbs / 6.61ft L: 5lbs

### WARRANTY

5 year limited warranty.

# OZ 48V LARGE SURFACE/SUSPENSION PROFILE

## SPECIFICATION INFORMATION



Ex: 1T7083 / 1T7095 / 1T7065

1 - PROFILE	2 - END CAP	3 - MOUNTING	4 - JOINT CONNECTOR	5 - COVERS
<b>REQUIRED</b>	<b>REQUIRED</b>	<b>REQUIRED</b>	<b>OPTIONAL</b>	<b>OPTIONAL</b>

Plaster White Finish     Deep Black Finish

### 1 - PROFILE (REQUIRED)

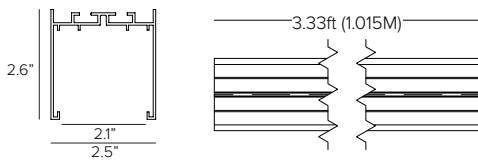

Field cuttable OZ LARGE surface/suspension aluminum profile for lead or standalone configurations.

Finish          
 Part No.    **1T7083**    **1T7086**



Field cuttable OZ LARGE surface/suspension aluminum profile for lead or standalone configurations.

Finish          
 Part No.    **1T7084**    **1T7087**

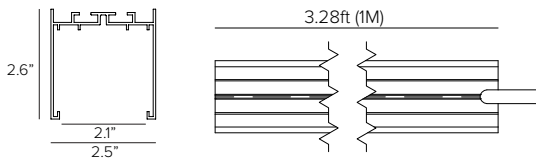

Field cuttable OZ LARGE surface/suspension aluminum profile for center and end configurations.

Finish          
 Part No.    **1T7077**    **1T7080**

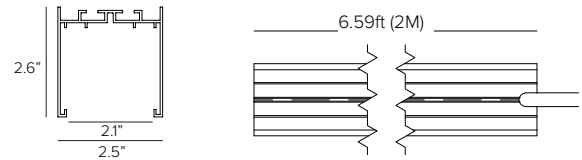

Field cuttable OZ LARGE surface/suspension aluminum profile for center and end configurations.

Finish          
 Part No.    **1T7078**    **1T7081**

### 2 - END CAP (REQUIRED)

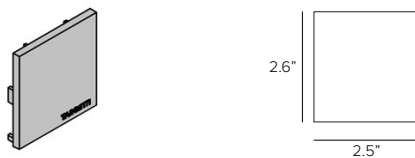

OZ LARGE surface/suspension end cap kit, 2pcs.

Finish          
 Part No.    **1T7095**    **1T7096**

# OZ 48V LARGE SURFACE/SUSPENSION PROFILE

## 3 - MOUNTING SYSTEM (REQUIRED)

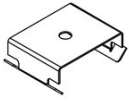

OZ surface profile installation clip, 1pc. Suggested 2pcs for 3ft (1M) L and 3pcs for 6.5ft (2M) L profiles.

Part No. **1T7065**



OZ suspension profile installation kit, includes 20ft L aircraft cable, 1pc. Suggested 2pcs for 3ft (1M) L and 3pcs for 6.5ft (2M) L profiles.

Part No. **1US7066**

## 4 - JOINT CONNECTORS (OPTIONAL)

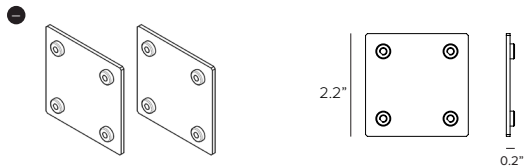

OZ surface/suspension profile linear joint connector kit, includes of 2pcs mechanical linear joints and 8pcs screws. Compatible with small and large suspended profiles.

Finish

Part No. **1T7064** **1T7097**



OZ LARGE surface/suspension profile L-joint connector.

Finish

Part No. **1T7089** **1T7092**

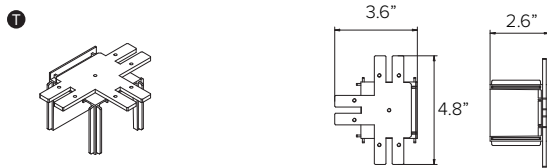

OZ LARGE surface/suspension profile T-joint connector.

Finish

Part No. **1T7090** **1T7093**

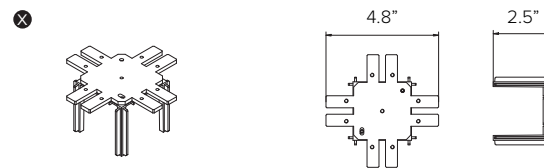

OZ LARGE surface/suspension profile X-joint connector.

Finish

Part No. **1T7091** **1T7094**

## 5 - COVER (OPTIONAL)

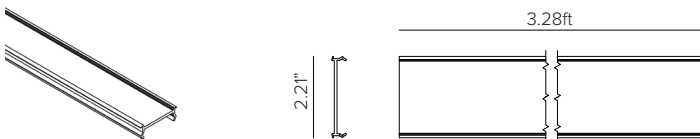

Field cuttable OZ LARGE surface/suspension cover.

Finish

Part No. **1T9599** **1T9601**

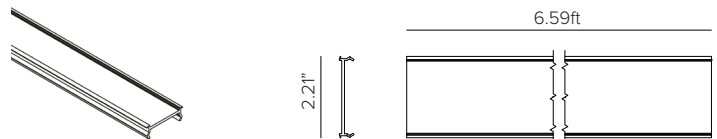

Field cuttable OZ LARGE surface/suspension cover.

Finish

Part No. **1T9600** **1T9602**

# OZ 48V LARGE SURFACE/SUSPENSION PROFILE

## INSTALLATION DIAGRAMS

**NOTE: Max of 4 connectors (excluding power feed) or 30ft or power rail per individual power supply.**

### CEILING OR SUSPENSION INSTALLATION

*OZ Power Rail + OZ Surface / Suspended Profile*

