

KEPLERO MINI HIGH EFFICACY RGBW

Professional Inground Fixed LED Fixture

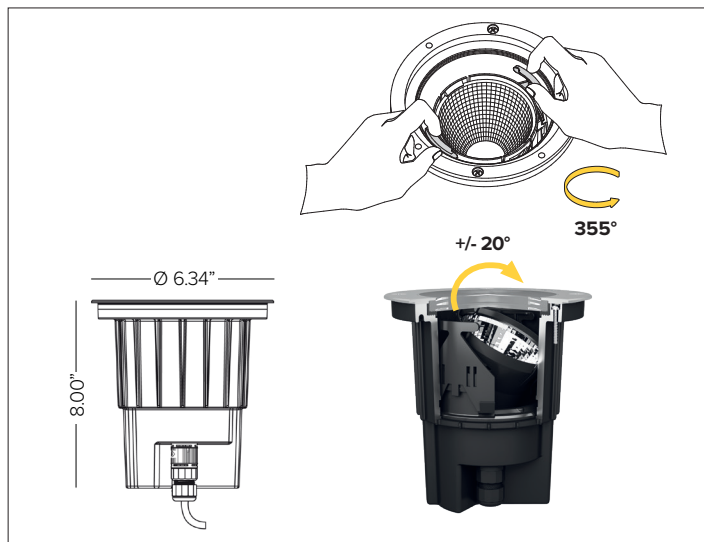

KEPLERO® Mini High Efficacy RGBW with brushed natural trim and clear lens



CONCEPT

Compact inground luminaire with high intensity RGBW LED's for dynamic color changing illumination.

MECHANICAL CHARACTERISTICS

Housing	8"H x 6.34"Dia. housing.
Materials	Anodized marine grade cataphoresis ^A die-cast aluminum heat sink body with PVC installation sleeve. AISI316L stainless steel trim ring with beveled edge with extra clear glass lens.
Finish	<input type="radio"/> Brushed Natural <input type="radio"/> Bronze PVD* <input type="radio"/> Black PVD* *Physical Vapor Deposition.
Power Connection	Required 20-8 awg direct burial lead cable with quick disconnect in 10ft / 25ft / 50ft lengths, see required options.
Functionality	Adjustable +/-20° on the vertical axis and rotated 355° on the horizontal axis with friction locking mechanism.
Mounting	Flush, semi-flush or raised tube mountings. Installation sleeve for flush or semi-flush mountings includes optional stainless steel 'L' brackets for additional mounting support. Fixture equipped with fastening holes and stainless steel screws for attachment into installation sleeve assembly.
Weight	2.4lbs
Protection	IP68 ^B / IP69K
Impact	IK10
Load	Resistant to static loads up to 4,496lbs in flush mounted cement and pavement installations.

CERTIFICATIONS

cULus Class2 Wet Location Listed.
 Tested in accordance with LM-79-08.
 Compliant for California installations.
 IEC 62471
 RoHS3 EU 215/863

SUSTAINABILITY

Luminaire designed for disposal/recycling at end-of-life. Replaceable LED light source and control gear by a Targetti technician.

ELECTRICAL CHARACTERISTICS

Power Supply	Remote Class 2 power supply with DMX/RGBW interface required, see available options. Refer to Targetti Onsite Services for additional programing and installation support.
Wattage	15W / 4Ch
Voltage	450mA @ 9-12V DC per channel

SOURCE

High efficiency RGBW LED quad chip.

TM30	CCT (Nominal)	SDCM
	RGBW 5500K	2

OPTIC

Silicone diffuser lens and metalized polycarbonate reflector with different beam openings.

Beam		SP 18°	FL 33°	MWFL 49°
Delivered Lumens	RED	126Lm	126Lm	124Lm
	GREEN	201Lm	201Lm	198Lm
	BLUE	49Lm	49Lm	48Lm
	5500K	291Lm	291Lm	287Lm
	RGB	361Lm	362Lm	365Lm
	RGBW	656Lm	657Lm	647Lm
Efficacy	70Lm/W max. Refer to photometric graphs for specific values.			
Lifetime	L80/B10 60,000hrs at max TA +25°C			
Photobiological Classification	Low risk safety RG1			

WARRANTY

5 year limited warranty.
^A Fixture body complete with marine grade cataphoresis suitable for use in marine grade environments. Stainless steel trim will need to be maintained and cleaned regularly to avoid mineral deposits. Not to be in direct contact with salt or corrosive agents for extended periods of time.
^B Temporary immersion up to 24 hours at a max depth of 2 meters. Installation of fixture requires proper drainage to prevent any standing water. Should not be used for permanent submersion.

KEPLERO MINI HIGH EFFICACY RGBW

SPECIFICATION INFORMATION

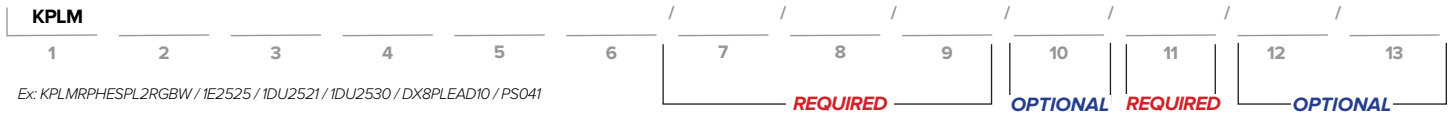

Ex: KPLMRPHESPL2RGBW / 1E2525 / 1DU2521 / 1DU2530 / DX8PLEAD10 / PS041

1 - PRODUCT CODE	2 - DRIVER	3 - TYPE	4 - OPTIC	5 - WATTAGE	6 - KELVIN
KPLM — KEPLERO Mini	RP — Remote Driver	HE — High Efficacy	SP — SP 18° FL — FL 33° MW — MWFL 49°	L2 — 15W	RGBW — RGBW
7 - TRIM	8 - INSTALLATION	9 - INSTALLATION ACCESSORIES	10 - LEAD CABLE	11 - POWER SUPPLY	12 - CONTROL
Round Trim Ring See section for details Square Trim Ring See section for details	Flush Mount Sleeve See section for details Raised Tube See section for details	Torx Key See section for details Fixture Removal Tool See section for details Glass Removal Tool See section for details	Lead Cable See section for details	DMX Power Supply See section for details	DMX Controller See section for details
13 - OPTICAL ACCESSORIES					
Holder Ring See section for details Anti Glare Honeycomb Louver See section for details Half Moon Anti Glare Shutter See section for details					

KEPLERO MINI HIGH EFFICACY RGBW

7 - TRIM (REQUIRED)

ROUND TRIM RING



Round stainless steel (AISI316L) decorative ring. 10mm thick extra clear protective glass. Silicone gasket. Tamper proof (AISI316L) Torx screws.

Finish ● Brushed Natural ● Bronze PVD ● Black PVD

Part No. **1E2525** **1DU2525B** **1DU2525K**



Round stainless steel (AISI316L) decorative ring with anti-slip glass. 10mm thick extra clear protective glass. Silicone gasket. Tamper proof (AISI316L) Torx screws.

Finish ● Brushed Natural ● Bronze PVD ● Black PVD

Part No. **1DU2525A** **1DU2525BA** **1DU2525KA**



Round stainless steel (AISI316L) decorative ring with half frosted glass. 10mm thick extra clear protective glass. Silicone gasket. Tamper proof (AISI316L) Torx screws.

Finish ● Brushed Natural ● Bronze PVD ● Black PVD

Part No. **1DU2525E** **1DU2525BE** **1DU2525KE**

SQUARE TRIM RING



Square stainless steel (AISI316L) decorative ring. 10mm thick extra clear protective glass. Silicone gasket. Tamper proof (AISI316L) Torx screws.

Finish ● Brushed Natural

Part No. **1E2526**



Square stainless steel (AISI316L) decorative ring. 10mm thick extra clear protective glass. Silicone gasket. Tamper proof (AISI316L) Torx screws.

Finish ● Brushed Natural

Part No. **1DU2526A**



Square stainless steel (AISI316L) decorative ring. 10mm thick extra clear protective glass. Silicone gasket. Tamper proof (AISI316L) Torx screws.

Finish ● Brushed Natural

Part No. **1DU2526E**

KEPLERO MINI HIGH EFFICACY RGBW

8 - INSTALLATION (REQUIRED)

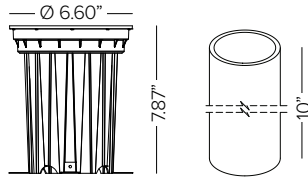

Installation sleeve for concrete pour applications. Grey Nylon casing with PVC installation outer pipe. For flush or semi-flush installations.

Part No. **1DU2521**

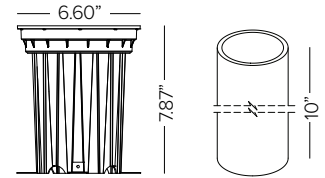

Installation sleeve for concrete pour applications. Grey Nylon casing and stainless steel profile with PVC installation outer pipe. Square ring for flush installation only. **For use with square trim options only.**

Part No. **1DU2522**

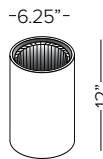

At grade or raised installation sleeve for turf or ground cover applications. 12"H stainless steel, includes factory pre-installed inner PVC installation sleeve. **To be used with round trim options only. Not suitable for use with 1DU2521 or 1DU2522.** (Field cuttable. Used for fixture elevations at grade to 3" above grade).

Finish ● Deep Black

Part No. **1DU4344-12**

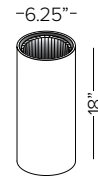

Raised installation sleeve for ground cover (succulents and low level planting) applications. 18"H stainless steel, includes factory pre-installed inner PVC sleeve. **To be used with round trim options. Not suitable with 1DU2521 or 1DU2522.** (Field cuttable. Used for fixture elevation 7" above grade).

Finish ● Deep Black

Part No. **1DU4344-18**

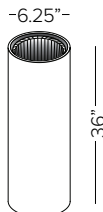

Raised installation sleeve for landscape applications. 36"H stainless steel, includes factory pre-installed inner PVC sleeve. **To be used with round trim options. Not suitable with 1DU2521 or 1DU2522.** (Field cuttable. Used for fixture elevation 21" above grade).

Finish ● Deep Black

Part No. **1DU4344**

9 - INSTALLATION ACCESSORIES (OPTIONAL)



Fixture metal maintenance removal handle. Helpful one per 10 fixtures.

Part No. **1E2524**



Anti-vandal torx head. Helpful one per 5 fixtures.

Part No. **1E2495**



Glass suction removal tool. Helpful one per 20 fixtures.

Part No. **1E0388**

KEPLERO MINI HIGH EFFICACY RGBW

10 - LEAD CABLE (REQUIRED)







20-8 awg direct burial lead cable with quick disconnect.

Length	10ft	25ft	50ft
Part No.	DX8PLEAD10	DX8PLEAD25	DX8PLEAD50

11 - POWER SUPPLY (REQUIRED)

STANDALONE							
Part No.	Wattage	Control	Dim Range	In / Out Voltage	Certification	Dimensions (Standalone)	Description
PS041	50W 450mA 4 chan	DMX / RDM <i>1 fixture max</i>	0%	Universal 120-277VAC	UR CLASS 2	6.00" x 3.00" x 1.20"	EldoLED POWERdrive 561/A1 Class 2 Power Supply, side feed only. UL listed enclosure provided by others.

12 - CONTROL (OPTIONAL)

Part No.		Channels	Scenes	Zones	Rating	Voltage	Certification	Dimensions	Description
TGDMXSLES AU9		256	20	1	Indoor	5.5V DC	ETL, UL	5.3"W x 5.5"H x 1.9D	Nicolaudio Slesa smart DMX 1/2 universe programmable controller with easy to use software interface.
TGDMXSLES AU11		1024	99	5	Indoor	5VDC 120V AC <i>Plug in power supply included</i>	ETL	6.3" x 3.6" x 1.8"	Nicolaudio Slesa smart DMX interface, 2 DMX 512 universes, intuitive backlit keyboard programmable controller with easy to use software interface.
TGDMXSTICKDE3B		1024	500	10	Indoor	6-7V DC 120V AC <i>Plug in power supply included</i>	ETL	5.8" x 4.2" x 0.5"	Nicolaudio intelligent control keypad with glass touch sensitive graphic display, stand-alone DMX 512, 2 universe programmable controller with easy to use software interface. Black finish.
TGDMXSTICKDE3W		1024	500	10	Indoor	6-7V DC 120V AC <i>Plug in power supply included</i>	ETL	5.8" x 4.2" x 0.5"	Nicolaudio intelligent control keypad with glass touch sensitive graphic display, stand-alone DMX 512, 2 universe programmable controller with easy to use software interface. White finish.

KEPLERO MINI HIGH EFFICACY RGBW

13 - OPTICAL ACCESSORIES (OPTIONAL)

MAXIMUM OF ONE OPTICAL FILTER OR LOUVER ACCESSORY PER FIXTURE

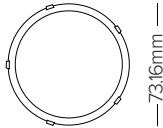

Transparent polycarbonate holder ring for the accessories. **Required for use of all filters and glare grid.**

Part No. **1T3727**

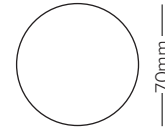

Anti-glare honeycomb louver with lacquered metal structure.

Finish ● Deep Black

Part No. **1T1711**

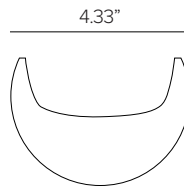

Integral half moon anti glare shutter. **Can be used as one per fixture with a filter or louver, not considered as part of the maximum optical accessories.**

Finish ● Deep Black

Part No. **1E2523**

KEPLERO MINI HIGH EFFICACY RGBW

INSTALLATION DIAGRAM

LANDSCAPE APPLICATION

RAISED TUBE INSTALLATION ASSEMBLY

Recommended for Landscape Installation
1DU4344 with Round Trim ONLY

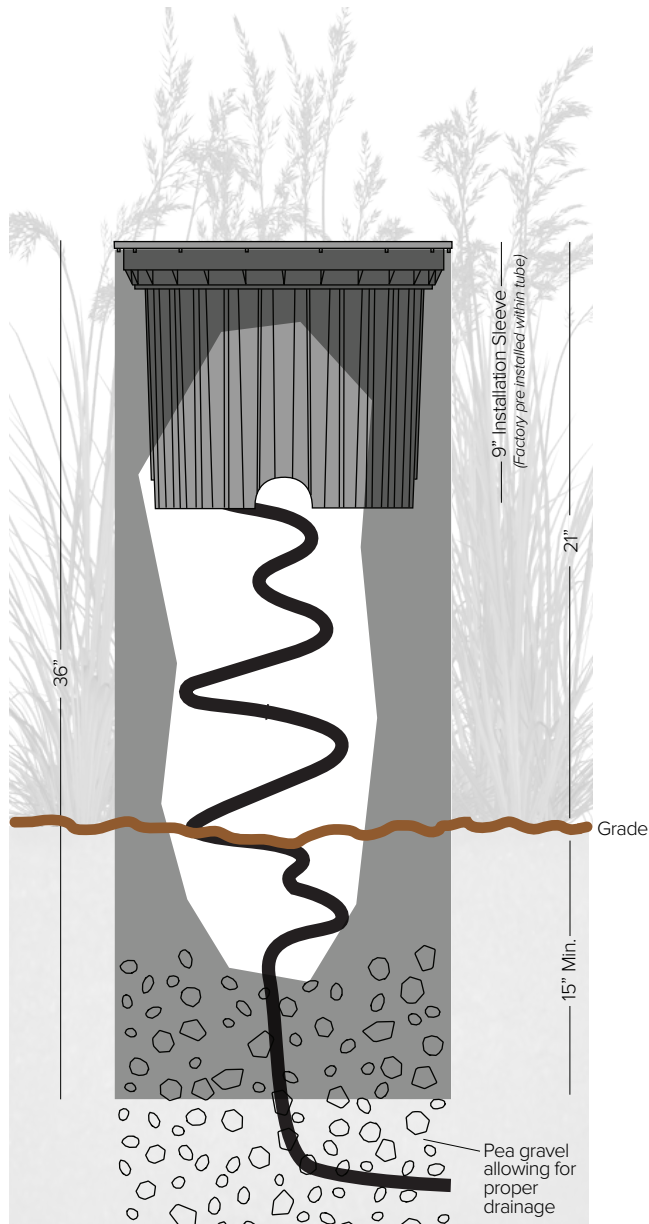

RAISED TUBE INSTALLATION ASSEMBLY

Recommended for Ground Level Installation
1DU434418 with Round Trim ONLY

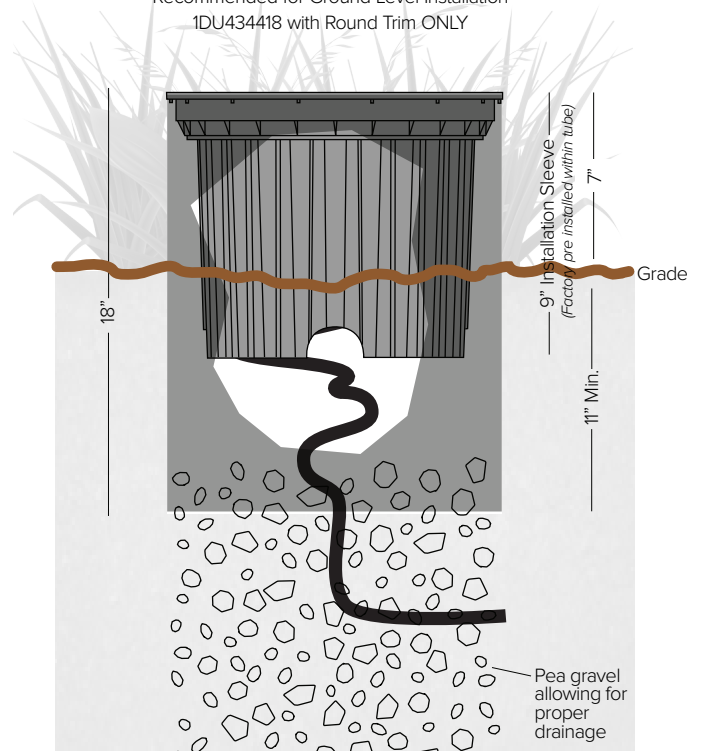

RAISED TUBE INSTALLATION ASSEMBLY

Recommended for Turf Installation
1DU434412 with Round Trim ONLY

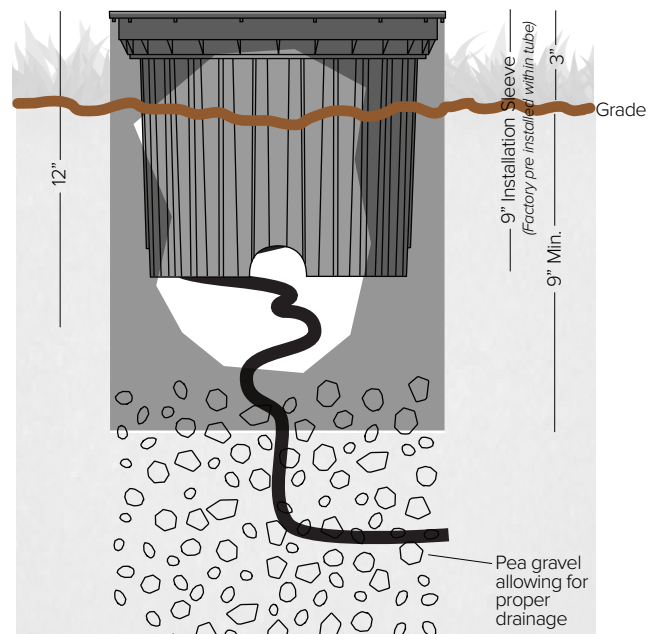

KEPLERO MINI HIGH EFFICACY RGBW

INSTALLATION DIAGRAM

CONCRETE POUR APPLICATION



Flush Mount Sleeve Assembly
1DU2521 and 1DU2522 Sleeves

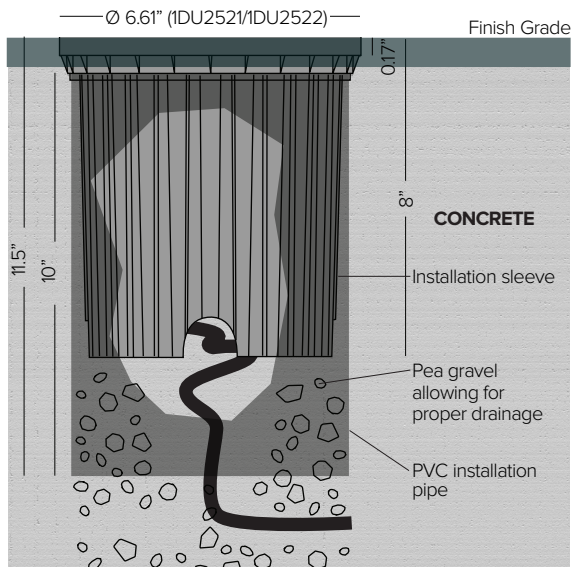

Semi-Flush Mount Sleeve Assembly
1DU2521 Sleeve Only

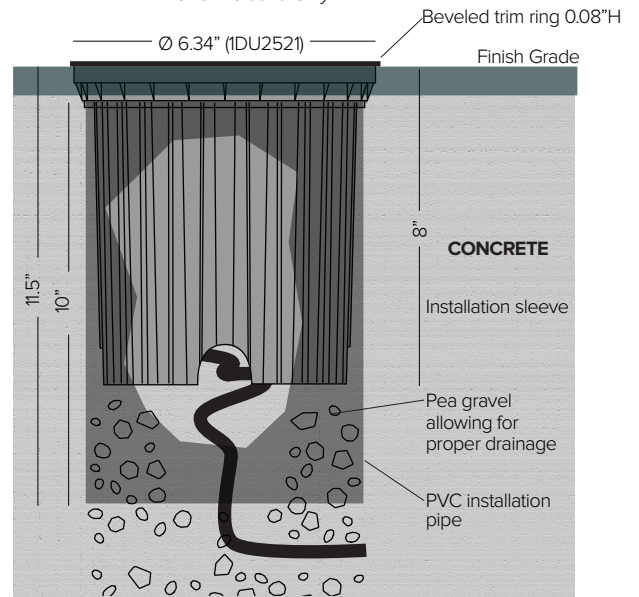

WIRING DIAGRAM

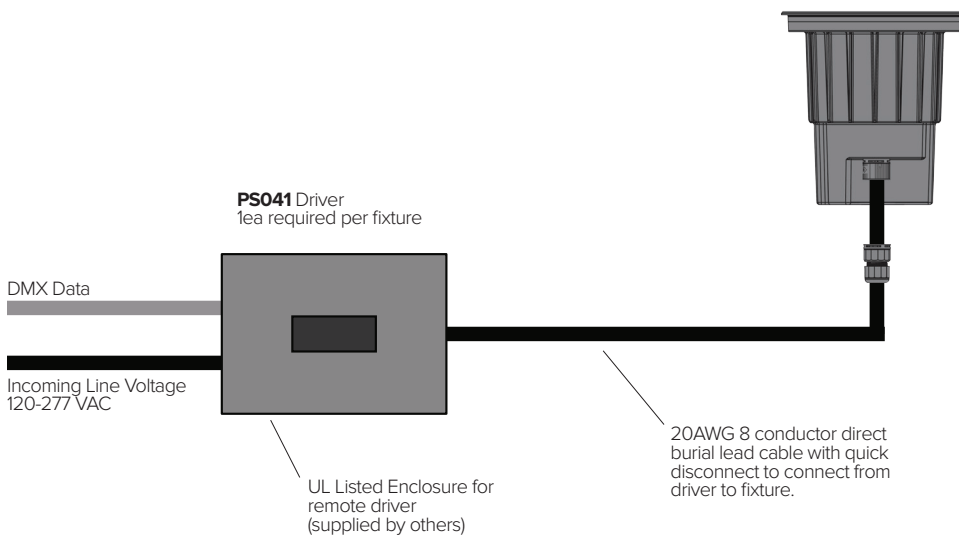

KEPLERO MINI HIGH EFFICACY RGBW

PHOTOMETRY

SPOT / RED



		H(m)	D(m)	Emax(lx)
	-			
	-		18°	
Fixture Power	3W	1	0.32	740
Source Flux	168lm	2	0.63	185
Fixture Flux	126lm	3	0.95	82
Efficacy	43lm/W	4	1.27	46
TS1412	Imax=4407cd/klm	Imax	740cd	5
			1.58	30

SPOT / GREEN



		H(m)	D(m)	Emax(lx)
	-			
	-		18°	
Fixture Power	4W	1	0.32	1181
Source Flux	268lm	2	0.63	295
Fixture Flux	201lm	3	0.95	131
Efficacy	49lm/W	4	1.27	74
TS1412	Imax=4407cd/klm	Imax	1181cd	5
			1.58	47

SPOT / BLUE



		H(m)	D(m)	Emax(lx)
	-			
	-		18°	
Fixture Power	4W	1	0.32	288
Source Flux	65lm	2	0.63	72
Fixture Flux	49lm	3	0.95	32
Efficacy	12lm/W	4	1.27	18
TS1412	Imax=4407cd/klm	Imax	288cd	5
			1.58	12

SPOT / RGB



		H(m)	D(m)	Emax(lx)
	-			
	-		18°	
Fixture Power	11W	1	0.32	2122
Source Flux	482lm	2	0.63	531
Fixture Flux	361lm	3	0.95	236
Efficacy	33lm/W	4	1.27	133
TS1412	Imax=4407cd/klm	Imax	2122cd	5
			1.58	85

SPOT / RGBW

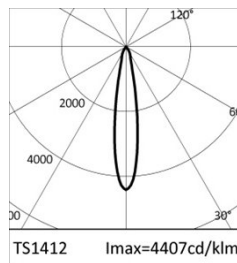

		H(m)	D(m)	Emax(lx)
	-			
	-		18°	
Fixture Power	15W	1	0.32	3858
Source Flux	875lm	2	0.63	965
Fixture Flux	656lm	3	0.95	429
Efficacy	43lm/W	4	1.27	241
TS1412	Imax=4407cd/klm	Imax	3858cd	5
			1.58	154

SPOT / 5500K



		H(m)	D(m)	Emax(lx)
	-			
	-		18°	
Fixture Power	4W	1	0.32	1710
Source Flux	388lm	2	0.63	427
Fixture Flux	291lm	3	0.95	190
Efficacy	69lm/W	4	1.27	107
TS1412	Imax=4407cd/klm	Imax	1710cd	5
			1.58	68

KEPLERO MINI HIGH EFFICACY RGBW

PHOTOMETRY

FLOOD / RED



		H(m)	D(m)	Emax(lx)
	-		33°	
	-			
Fixture Power	3W	1	0.60	310
Source Flux	168lm	2	1.20	77
Fixture Flux	126lm	3	1.80	34
Efficacy	43lm/W	4	2.40	19
TS1413	I _{max} =1847cd/klm	I _{max}	310cd	5
			3.00	12

FLOOD / GREEN



		H(m)	D(m)	Emax(lx)
	-		33°	
	-			
Fixture Power	4W	1	0.60	495
Source Flux	268lm	2	1.20	124
Fixture Flux	201lm	3	1.80	55
Efficacy	49lm/W	4	2.40	31
TS1413	I _{max} =1847cd/klm	I _{max}	495cd	5
			3.00	20

FLOOD / BLUE



		H(m)	D(m)	Emax(lx)
	-		33°	
	-			
Fixture Power	4W	1	0.60	121
Source Flux	65lm	2	1.20	30
Fixture Flux	49lm	3	1.80	13
Efficacy	12lm/W	4	2.40	8
TS1413	I _{max} =1847cd/klm	I _{max}	121cd	5
			3.00	5

FLOOD / RGB



		H(m)	D(m)	Emax(lx)
	-		33°	
	-			
Fixture Power	11W	1	0.60	889
Source Flux	482lm	2	1.20	222
Fixture Flux	362lm	3	1.80	99
Efficacy	33lm/W	4	2.40	56
TS1413	I _{max} =1847cd/klm	I _{max}	889cd	5
			3.00	36

FLOOD / RGBW



		H(m)	D(m)	Emax(lx)
	-		33°	
	-			
Fixture Power	15W	1	0.60	1617
Source Flux	875lm	2	1.20	404
Fixture Flux	657lm	3	1.80	180
Efficacy	43lm/W	4	2.40	101
TS1413	I _{max} =1847cd/klm	I _{max}	1617cd	5
			3.00	65

FLOOD / 5500K



		H(m)	D(m)	Emax(lx)
	-		33°	
	-			
Fixture Power	4W	1	0.60	717
Source Flux	388lm	2	1.20	179
Fixture Flux	291lm	3	1.80	80
Efficacy	70lm/W	4	2.40	45
TS1413	I _{max} =1847cd/klm	I _{max}	717cd	5
			3.00	29

KEPLERO MINI HIGH EFFICACY RGBW

PHOTOMETRY

MEDIUM WIDE FLOOD / RED



		H(m)	D(m)	Emax(lx)
	-		49°	
Fixture Power	3W	1	0.91	185
Source Flux	168lm	2	1.82	46
Fixture Flux	124lm	3	2.73	21
Efficacy	42lm/W	4	3.64	12
TS1414	I _{max} =1100cd/klm	I _{max}	185cd	5 4.56 7

MEDIUM WIDE FLOOD / GREEN



		H(m)	D(m)	Emax(lx)
	-		49°	
Fixture Power	4W	1	0.91	295
Source Flux	268lm	2	1.82	74
Fixture Flux	198lm	3	2.73	33
Efficacy	48lm/W	4	3.64	18
TS1414	I _{max} =1100cd/klm	I _{max}	295cd	5 4.56 12

MEDIUM WIDE FLOOD / BLUE



		H(m)	D(m)	Emax(lx)
	-		49°	
Fixture Power	4W	1	0.91	72
Source Flux	65lm	2	1.82	18
Fixture Flux	48lm	3	2.73	8
Efficacy	12lm/W	4	3.64	4
TS1414	I _{max} =1100cd/klm	I _{max}	72cd	5 4.56 3

MEDIUM WIDE FLOOD / RGB



		H(m)	D(m)	Emax(lx)
	-		49°	
Fixture Power	11W	1	0.91	529
Source Flux	482lm	2	1.82	132
Fixture Flux	356lm	3	2.73	59
Efficacy	32lm/W	4	3.64	33
TS1414	I _{max} =1100cd/klm	I _{max}	529cd	5 4.56 21

MEDIUM WIDE FLOOD / RGBW

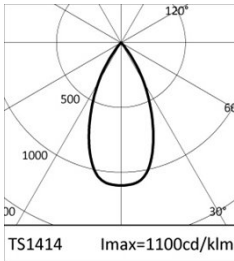

		H(m)	D(m)	Emax(lx)
	-		49°	
Fixture Power	15W	1	0.91	963
Source Flux	875lm	2	1.82	241
Fixture Flux	647lm	3	2.73	107
Efficacy	42lm/W	4	3.64	60
TS1414	I _{max} =1100cd/klm	I _{max}	963cd	5 4.56 39

MEDIUM WIDE FLOOD / 5500K



		H(m)	D(m)	Emax(lx)
	-		49°	
Fixture Power	4W	1	0.91	427
Source Flux	388lm	2	1.82	107
Fixture Flux	287lm	3	2.73	47
Efficacy	68lm/W	4	3.64	27
TS1414	I _{max} =1100cd/klm	I _{max}	427cd	5 4.56 17