

EUROSTANDARD PLUS MONOPOINT

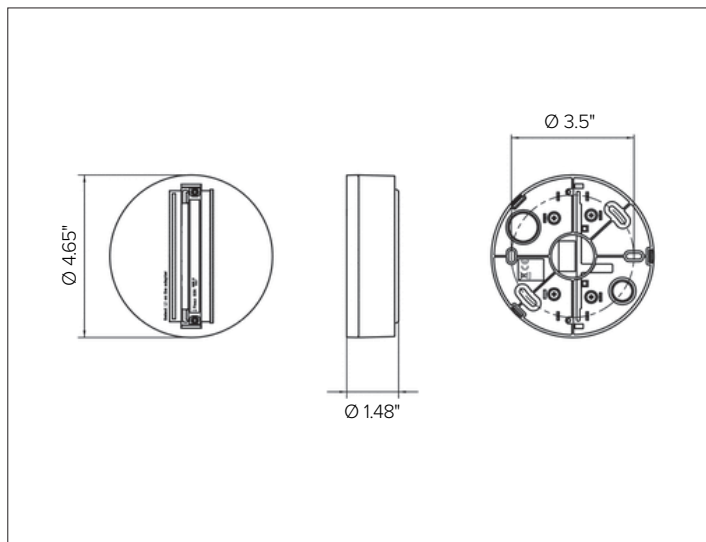

CONCEPT

Monopoint track mounting adapter for ceiling flush or recessed applications.

MECHANICAL CHARACTERISTICS

Dimensions	Ø 4.64" Dia.
Materials	Polycarbonate track adapter track with copper conductors that feed electricity to the fixture and provide attachment support.
Finish	<input type="radio"/> White <input checked="" type="radio"/> Black
Power Connection	Mechanical electrical polarized connections.
Mounting	Installs directly to j-box without the use of track.
Protection	IP20

ELECTRICAL CHARACTERISTICS

Voltage	120V/60Hz
Circuit	3-circuit, 4+2 conductor
Frequency	60Hz
Control	0-10V Dimming

CERTIFICATIONS

cULus Listed.
RoHS3 EU 215/863

WARRANTY

5 year limited warranty.

EUROSTANDARD PLUS MONOPOINT

SPECIFICATION INFORMATION

1

Ex: 9000/BPU-D-W

1 - MONOPOINT TRACK ADAPTOR

REQUIRED

1 - MONOPOINT TRACK ADAPTER (REQUIRED)



STUCCHI EUROSTANDARD PLUS monopoint track adapter for surface ceiling installations (REQUIRED). Installs directly to j-box without the use of track.

Finish White Black

Part No. **9000/BPU-D-W** **9000/BPU-D-B**

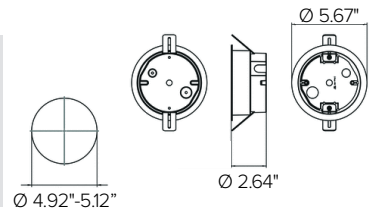

STUCCHI EUROSTANDARD PLUS recessed monopoint track adapter for surface ceiling installations (OPTIONAL). Connects directly to j-box without the use of track. **REQUIRED with the use of 9000/BPU-D.**

Finish White Black

Part No. **9000/BRU-W** **9000/BRU-B**



EUROSTANDARD PLUS MONOPOINT

7 – MOUNTING (REQUIRED)



Suspension kit, bracket with automatic gripper. Round head ceiling attachment with steel cable (Ø 0.06in X 16ft L), spherical end and short pendant bracket with countersink hole. Suggested 2pcs for 4ft L track, 3pcs for 8ft L track.

Finish White Black

Part No. **9000-KIT8-5-W** **9000-KIT8-5-B**



Suspension kit, bracket with automatic gripper. Screw gripper with finished plastic cup and steel cable (Ø 0.06in X 16ft L). Suggested 2pcs for 4ft L track, 3pcs for 8ft L track.

Finish White Black

Part No. **9000-KIT3-5-W** **9000-KIT3-5-B**

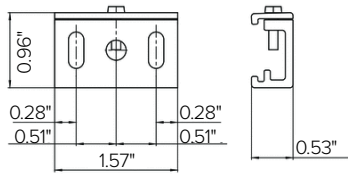

Track surface ceiling bracket. Suggested 2pcs for 4ft L track, 3pcs for 8ft L track.

Finish White Black

Part No. **S-9000/131-W** **S-9000/131-B**

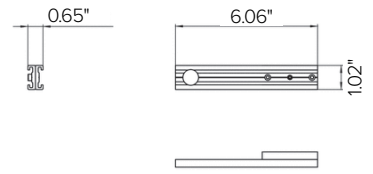

Reinforcing bracket for end feed. (OPTIONAL)

Finish White Black

Part No. **S-9001/SU-W** **S-9001/SU-B**

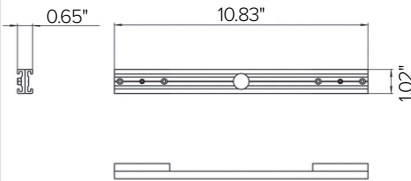
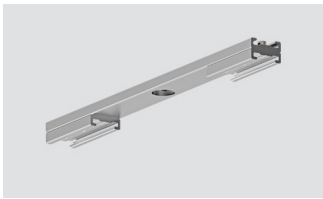

Reinforcing bracket for middle feed. (OPTIONAL)

Finish White Black

Part No. **S-9010/SU-W** **S-9010/SU-B**

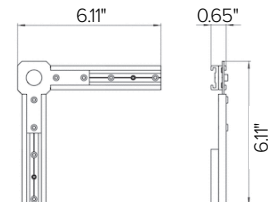
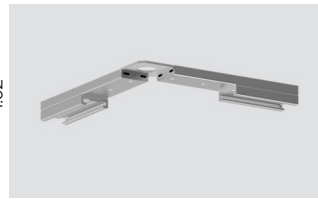

Reinforcing bracket for L-feed. (OPTIONAL)

Finish White Black

Part No. **S-9011/SU-W** **S-9011/SU-B**

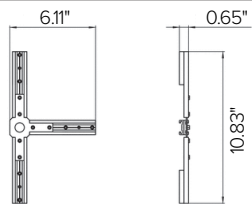
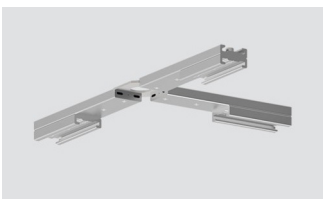

Reinforcing bracket for T-feed. (OPTIONAL)

Finish White Black

Part No. **S-9013/SU-W** **S-9013/SU-B**

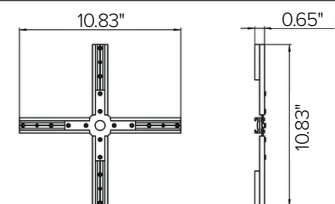
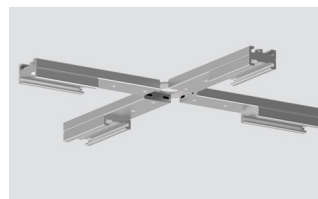

Reinforcing bracket for X-feed. (OPTIONAL)

Finish White Black

Part No. **S-9017/SU-W** **S-9017/SU-B**